

Wireless Noise Canceling Stereo Headset
WH-1000XM6



Model: YY2984

Quick Start Guide

Find your fit

[Wearing the headset](#)

Download the app, and set up the headset

Many useful features are out there in your device.
Download the “Sony | Sound Connect” and get the most out of what you have.



Let's start to use

1

Turning on the headset



Press and hold the  (power) button for about 2 seconds or more until the indicator (blue) flashes. The headset enters pairing mode automatically when you turn on the headset for the first time after purchase.

2



Establishing a BLUETOOTH® connection

Download the “Sony | Sound Connect” app.
Follow the downloaded “Sony | Sound Connect” app instructions.

3



Operating the headset

You can use the touch sensor control panel to perform the following operations.

- Tap twice quickly: Play/Pause
- Swipe forward and release: Skip to the beginning of the next track
- Swipe backward and release: Skip to the beginning of the previous track (or the current track during playback)
- Swipe up and release: Increase the volume
- Swipe down and release: Lower the volume

For more details on operations, refer to “Controlling the audio device (Bluetooth connection)”.

To prevent burning or malfunction due to getting wet

The headset is not waterproof.

If the headset is charged while it is wet with rain or sweat, etc., this can result in burnout or malfunction.

Note

- If you put on the headset without adjusting the slider, the headset may not be positioned properly on your head, resulting in discomfort or a weak noise canceling effect.
The wearing detection function of the headset may also not work properly and cause music playback to stop automatically or activate the automatic power off function (the battery saving function) to automatically turn off the headset.

Related information

[Wearing the headset](#)

[Establishing a Bluetooth connection manually](#)

[Charging the headset](#)

Getting started

[What you can do with the Bluetooth function](#)

[About the voice guidance](#)

Supplied accessories

[Included items](#)

[Setting the headset in the carrying case](#)

Parts and controls

[Location and function of parts](#)

[About the indicator](#)

Wearing the headset

[Wearing the headset](#)

Operating the headset

[About the touch sensor control panel](#)

[Using Quick Access](#)

Power/Charging

[Charging the headset](#)

[Available operating time](#)

[Checking the remaining battery charge](#)

[Turning on the headset](#)

[Turning off the headset](#)

Making connections

[How to make a wireless connection to Bluetooth devices](#)

Easy setup with app

[Connecting with the "Sony | Sound Connect" app](#)

Android smartphone

[Pairing and connecting with an Android smartphone](#)

[Pairing and connecting with an Android smartphone using LE Audio](#)

[Connecting to a paired Android smartphone](#)

iPhone (iOS devices)

[Pairing and connecting with an iPhone](#)

[Connecting to a paired iPhone](#)

Computers

[Pairing and connecting with a computer \(Windows® 11\)](#)

[Pairing and connecting with a computer \(Windows 10\)](#)

[Pairing and connecting with a computer \(Mac\)](#)

[Connecting to a paired computer \(Windows 11\)](#)

- [Connecting to a paired computer \(Windows 10\)](#)

- [Connecting to a paired computer \(Mac\)](#)

Other Bluetooth devices

- [Pairing and connecting with a Bluetooth device](#)

- [Connecting to a paired Bluetooth device](#)

Multipoint connection

- [Connecting the headset to 2 devices simultaneously \(multipoint connection\)](#)

[Switching audio between multiple devices with “audio switch”](#)

[Sharing music with “Auracast™ broadcast audio”](#)

[Disconnecting Bluetooth connection \(after use\)](#)

[Using the supplied headphone cable](#)

Listening to music

Listening to music via a Bluetooth connection

- [Listening to music from a device via a Bluetooth connection](#)

- [Controlling the audio device \(Bluetooth connection\)](#)

- [About 360 Reality Audio](#)

- [Enjoying seamless playback with speakers \(Auto Switch\)](#)

Noise canceling function

- [What is noise canceling?](#)

- [Using the noise canceling function](#)

- [Always automatically optimizing the noise canceling performance to suit the wearer and usage environment](#)

Listening to ambient sound

- [Listening to ambient sound during music playback \(Ambient Sound Mode\)](#)

- [Automatically adjusting the level of ambient sound capture according to the ambient noise level \(Auto Ambient Sound\)](#)

- [Listening to ambient sound quickly \(Quick Attention Mode\)](#)

- [Speaking with someone while wearing the headset \(Speak-to-Chat\)](#)

Sound quality mode

- [About the sound quality mode](#)

- [Supported codecs](#)

[About the DSEE Extreme function](#)

[Using 360 Upmix for Cinema](#)

Making phone calls

[Receiving a call](#)

[Making a call](#)

[Functions for a phone call](#)

[Making a video call on your computer](#)

Using the voice assist function

[Using Voice Control](#)

[Using Google Assistant](#)

[Using Tencent Xiaowei](#)

[Using the voice assist function \(Google app\)](#)

[Using the voice assist function \(Siri\)](#)

Using the apps

[What you can do with the “Sony | Sound Connect” app](#)

[Installing the “Sony | Sound Connect” app](#)

[Accessing support information from the “Sony | Sound Connect” app](#)

[How to keep the software up-to-date \(for comfortable use of the headset\)](#)

What you can do with partner services

[What you can do with partner services](#)

Important information

[Precautions](#)

[To prevent burning or malfunction due to getting wet](#)

[Licenses](#)

[Trademarks](#)

[Customer support websites](#)

Troubleshooting

[Troubleshooting](#)

[Resetting the headset](#)

[Initializing the headset to restore factory settings](#)

Specifications

[Specifications](#)

5-063-141-11(5) Copyright 2025 Sony Corporation

Wireless Noise Canceling Stereo Headset
WH-1000XM6

What you can do with the Bluetooth function

The headset uses Bluetooth wireless technology, allowing you to do the following.

Listening to music

You can enjoy music wirelessly from a smartphone or music player, etc.



Talking on the phone

You can talk on the phone hands-free, while leaving your smartphone in your bag or pocket.



Wireless Noise Canceling Stereo Headset
WH-1000XM6

About the voice guidance

In the factory settings, when you put the headset on your ears, you will hear the voice guidance in either English or Chinese.

You can use the “Sony | Sound Connect” app to change the language of the voice guidance, turn the voice guidance on/off, and set the voice guidance volume.

“Pairing”

- When entering pairing mode

“Low battery”

- When the remaining battery charge of the headset is low

“Battery is empty”

- When automatically turning off due to low battery of the headset

“Battery about XX %” / “Battery fully charged”

- When informing the remaining battery charge
The “XX” value indicates the approximate remaining charge. Use it as a rough estimate.

“Voice guidance test”

- When setting the voice guidance volume

“The Google Assistant is not connected” *

- When Google™ Assistant is not available on the smartphone connected to the headset even if you operate the touch sensor control panel

* May not be supported in some countries or regions.

“The Xiaowei is not connected”

- When Tencent Xiaowei is not available on the smartphone connected to the headset even if you operate the touch sensor control panel

“The Voice Assistant is not available. Please open the Sound Connect and check the Voice Assistant settings.”

- When operating Voice Assistant while connected in LE Audio

“Launch the Sound Connect to activate the Service Link.”

- When Quick Access is not available because Service Link is turned off

“App assigned to the Quick Access is not launched on the mobile device”

- When the corresponding app does not start even if the NC/AMB (noise canceling/Ambient Sound Mode) button is pressed when Quick Access is set to the NC/AMB (noise canceling/Ambient Sound Mode) button

“The Quick Access is not available. Please open the Sound Connect and check the Quick Access settings.”

- When operating Quick Access while connected in LE Audio

“The [Safe volume control] limits the volume.”

- When Safe Volume Control starts

“Apologies, the command could not be recognized”

- When Voice Control does not recognize the command after recognizing the wake word

“The voice assistant on your mobile device is not responding. Please check your settings.”

- When Voice Control recognizes "Assistant" but the voice assist function does not activate

“Mic Off”

- When the headset was operated to turn off the microphone during a call

“Mic On”

- When the headset was operated to turn on the microphone during a call

Liquid detected in the USB port. Do not charge the headset.

- When the USB Type-C port has detected moisture, and you turn the headset on and wear it
- When moisture is detected in the USB Type-C port after the headset is turned on and worn

Liquid detected in the USB port. Battery level is low, but do not charge the headset.

- When moisture is detected in the USB Type-C port, and the remaining battery charge becomes low while the headset is turned on and worn
- When moisture is detected in the USB Type-C port while the remaining battery charge is low, and the headset is turned on and worn

Liquid no longer detected in the USB port. You can start charging the headset.

- When moisture is no longer detected in the USB Type-C port and charging becomes available while the headset is turned on and worn with low remaining battery charge

“Charging stopped. To resume charging, disconnect the USB cable and wait before trying again.”

- When abnormal charging or abnormal charging temperature occurs while using the headset during charging

Note

- It takes about 10 minutes for a change to the voice guidance language to be applied. It may take more than 10 minutes depending on your signal reception and other conditions.
- When you initialize the headset to restore to the factory settings after you change the language of the voice guidance, the language will also return to the factory settings.
- If the voice guidance is not heard after changing the voice guidance language or updating the software, turn the headset off and on again.

Wireless Noise Canceling Stereo Headset
WH-1000XM6

Included items

After opening the package, check that all of the items in the list are included. If any items are missing, consult the Sony support contact or your nearest Sony dealer.

Numbers in () indicate the item amount.

Wireless Noise Canceling Stereo Headset (1)

USB Type-C® cable (USB-A to USB-C®) (1)



Headphone cable (1)

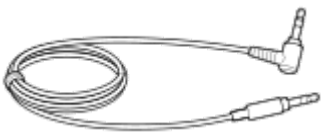

Carrying case (1)

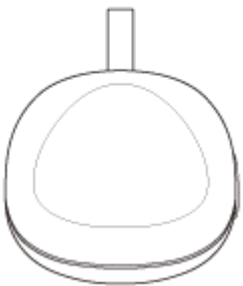

Documents (1 set)

Wireless Noise Canceling Stereo Headset
WH-1000XM6

Setting the headset in the carrying case

When you have finished using the headset, adjust the slider to its shortest position, and rotate the left and right units to flatten the headset. Fold the left unit towards the headband, and store the headset in the supplied carrying case.

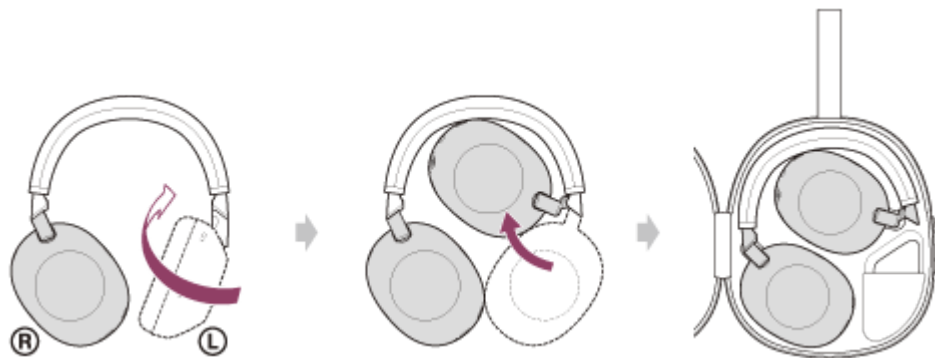

To store the cables

Put the cables in the holder separated by the divider in the carrying case.

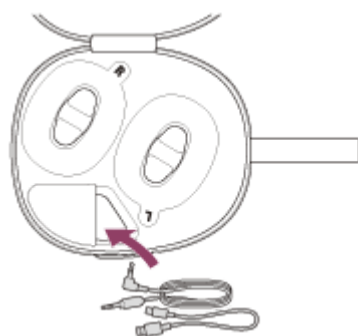

About the instruction manual video

Watch the video to find out how to set the headset in the carrying case.

No audio explanation is available.

For models of countries and regions excluding Chinese mainland:

https://rd1.sony.net/help/mdr/mov0091/h_zz/

For models of Chinese mainland:

<https://rd1.sony.net/help/mdr/mov0091/zh-cn/>

Location and function of parts

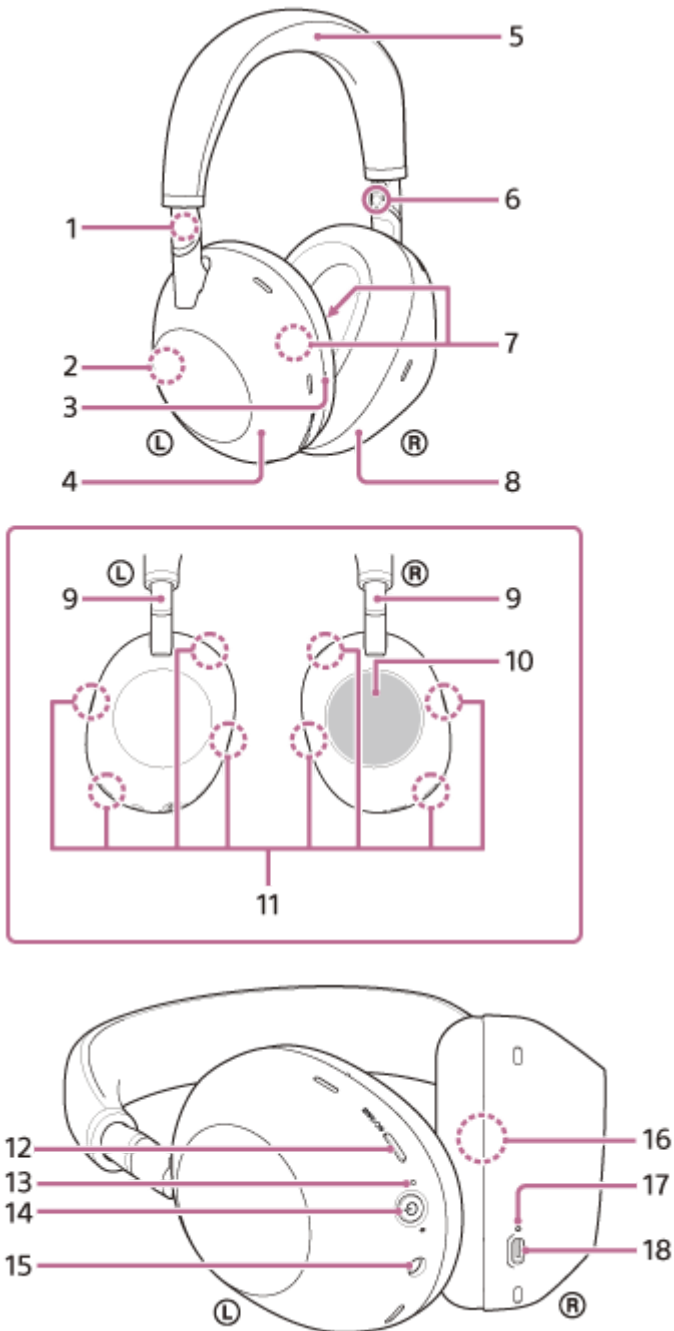

1. Ⓛ (left) mark
2. Built-in antenna
A Bluetooth antenna is built into the headset.
3. Tactile dot
The left unit has a tactile dot at the edge of the housing.
4. Left unit
5. Headband

6. ® (right) mark
7. Noise canceling function microphones (internal) (left, right)
Pick up the sound of the noise when the noise canceling function is in use.
8. Right unit
9. Sliders (left, right)
Slide to adjust the length of the headband.
10. Touch sensor control panel
Remotely controls music playback of the connected Bluetooth device or performs other operations using touch operation.
11. Noise canceling function microphones (external) and voice pickup microphones (left, right)
Pick up the sound of the noise when the noise canceling function is in use and the wearer's voice during a phone call or when the Speak-to-Chat mode is in use.
12. NC/AMB (noise canceling/Ambient Sound Mode) button
13. Indicator (orange/blue)
Lights up in orange or blue to indicate the battery or communications status of the headset.
14. ⏻ (power) button / 📶 (Bluetooth) button
15. Headphone cable input jack
Connect a music player, etc. using the supplied headphone cable. Make sure that you insert the cable until it clicks. If the plug is not connected correctly, you may not hear the sound properly.
16. Serial number
Located inside the right unit.
See "To check serial numbers, safety marks, etc." below.
17. Charging indicator (orange)
Lights up in orange while charging.
18. USB Type-C port
Connect the headset to a computer, or to an AC outlet via a commercially available USB AC adaptor, with the supplied USB Type-C cable to charge the headset.

To check serial numbers, safety marks, etc.

- Make sure the headset is turned off and the USB cable is not connected.
- Remove the earpad from the right unit by pulling it straight off the housing. Avoid pulling it off at an angle. The serial number and safety marks, etc. are located on the lower right corner of the right unit.

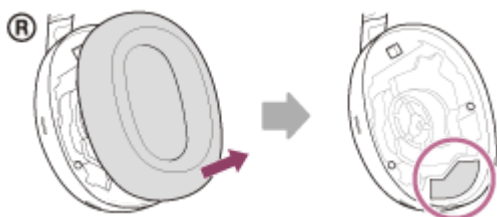

- Attach the removed earpad to the right unit.
Make sure to firmly insert the five tabs into the unit until you hear a click.

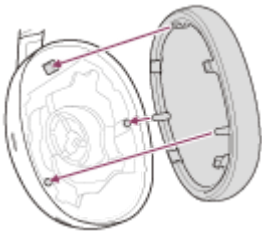

Note

- Do not remove the earpad unless necessary.
- Before removing the earpad, make sure the headset is turned off and the USB cable is not connected.
- Do not remove the earpad in the presence of iron sand or other metal objects. Iron sand or other metal objects may adhere to the magnet inside the headset, causing the headset to malfunction.
- Any defects caused by failure to follow the above precautions are not covered by the product warranty.

Related Topic

- [About the indicator](#)
- [Checking the remaining battery charge](#)
- [About the touch sensor control panel](#)

Wireless Noise Canceling Stereo Headset
WH-1000XM6

About the indicator

You can check various statuses of the headset by the indicator.

● : Turns on in blue / ● : Turns on in orange / -: Turns off

Indicator (blue/orange) next to the (power) button

Turning on

● -- ● -- (flashes twice in blue)

In this case, when the remaining battery charge is 10% or lower (requires charging), the indicator lights successively as follows.

● -- ● -- (repeatedly flashes slowly in orange for about 15 seconds)

Turning off

● ---- (lights up in blue for about 2 seconds)

Displaying the remaining battery charge

- Remaining charge: More than 10%
 - -- ● -- (flashes twice in blue)
- Remaining charge: 10% or lower (requires charging)
 - -- ● -- (repeatedly flashes slowly in orange for about 15 seconds)

For details, see "[Checking the remaining battery charge](#)".

When the remaining battery charge becomes low

● -- ● -- (repeatedly flashes slowly in orange for about 15 seconds)

Bluetooth function

- Pairing mode
 - - ● ---- ● - ● ---- ● - ● (repeatedly flashes twice in blue)
- Not connected
 - ---- ● ---- (repeatedly flashes in blue at about 1-second intervals)
- Connection process completed
 - - ● - ● - ● - ● - ● - ● - ● - (repeatedly flashes quickly in blue for about 5 seconds)
- Connected
 - ---- ● ---- (repeatedly flashes in blue at about 5-second intervals)
- Incoming call
 - -- ● -- ● -- ● -- ● -- ● -- (repeatedly flashes quickly in blue)

The unconnected and connected status indications automatically turn off after a period of time has passed. They start flashing again for a period of time when some operation is performed. When the remaining battery charge becomes low, the indicator starts flashing in orange.

Other

- Headphone cable connected (power is turned on)
 - - - - - ● - - - - (repeatedly flashes in blue at about 5-second intervals)

The indicator turns off automatically after a period of time has passed. When the remaining battery charge becomes low, the indicator starts flashing in orange.
- Updating software
 - - ● - - - - ● - ● - - - - ● - ● - - - - (repeatedly flashes in orange and blue with an interval of about 0.6 seconds)
- Initialization completed
 - - ● - ● - ● - (flashes 4 times in blue)

For details, see [“Initializing the headset to restore factory settings”](#).

USB Type-C port charging indicator (orange)

Charging

- While charging
 -  (lights up in orange)



The indicator turns off after charging is complete.
- Abnormal temperature
 - ● - - ● ● - - (repeatedly flashes twice in orange)
- Abnormal charging
 -  - - (repeatedly flashes slowly in orange)

Related Topic

- [Checking the remaining battery charge](#)
- [Initializing the headset to restore factory settings](#)

Wearing the headset

1 Check the left and right units of the headset.

On the left unit, there are the  (left) mark, a tactile dot (A), the  (power) button, and the NC/AMB (noise canceling/Ambient Sound Mode) button.

On the right unit, there is the  (right) mark. There is no tactile dot or button.



2 Extend the slider.

Extend the slider to its full length before putting on the headset.

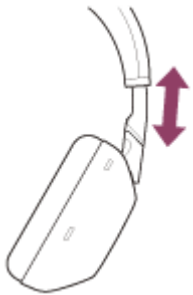

3 Put on the headset.

Put on the headset with the earpads fitting snugly over your ears.

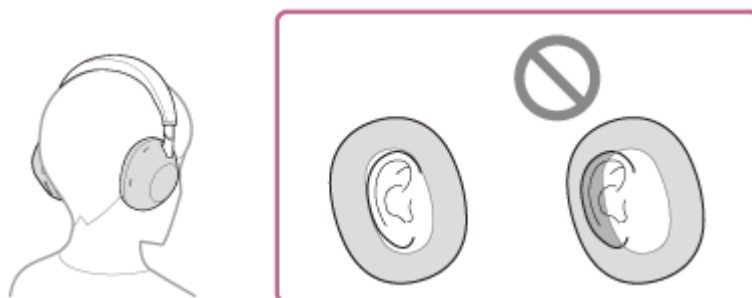

4 Adjust the length of the slider.

Adjust the slider to a length where the headband touches the top of your head.



5 Adjust the orientation of the units.

Adjust the orientation of the left and right units so that the earpads fit snugly all around your ears.



If you put on the headset without adjusting the slider, the headset may not be positioned properly on your head, resulting in discomfort or a weak noise canceling effect.

The wearing detection function of the headset may also not work properly and cause music playback to stop automatically or activate the automatic power off function (the battery saving function) to automatically turn off the headset.

When attaching and removing the headset

In the factory settings, the built-in proximity sensor in the left unit detects when the headset is worn or removed from your ears, and the headset automatically controls the disabling of the touch sensor control panel's operation, powering off the headset, pausing music playback, etc.

When the headset is worn

- You can use the touch sensor control panel of the headset to play music, make and receive calls, etc.

When the headset is removed

- When you listen to music while wearing the headset on your ears, the headset will pause music playback automatically if the headset is removed. When the headset is worn again, the headset resumes music playback.
- In order to save the battery, the headset will automatically turn off after 15 minutes of not being worn.
- In order to prevent the headset from reacting incorrectly, music playback, making and receiving calls, and other operations cannot be performed when the headset is removed, even if you tap the touch sensor control panel. The noise canceling function cannot be used even if you press the NC/AMB (noise canceling/Ambient Sound Mode) button.

About the instruction manual video

Watch the video to find out how to put the headset into your ears.

No audio explanation is available.

For models of countries and regions excluding Chinese mainland:

https://rd1.sony.net/help/mdr/mov0090/h_zz/

For models of Chinese mainland:

<https://rd1.sony.net/help/mdr/mov0090/zh-cn/>

Hint

- By using the “Sony | Sound Connect” app, you can change the settings of the wearing detection automatic music playback pause and resume function and the wearing detection automatic power off function (the battery saving function).

Note

- If you put on the headset without adjusting the slider, the headset may not be positioned properly on your head, resulting in discomfort or a weak noise canceling effect.
The wearing detection function of the headset may also not work properly and cause music playback to stop automatically or activate the automatic power off function (the battery saving function) to automatically turn off the headset.
- In the following cases, wearing detection may react incorrectly. When you are not using the headset, turn off the headset.
 - With the headset around your neck, your chin goes into the housing

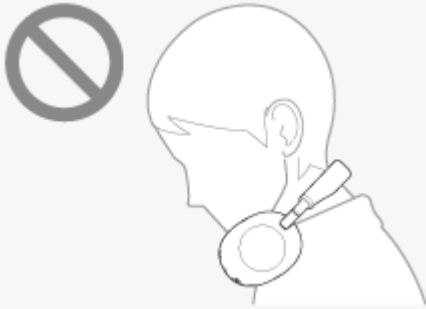

- Your hand is placed inside the earpad of the left unit.



- The headset is inside a container such as a bag.



- The headset is hanging on the edge of something such as a bag.



- The headset is on a surface such as a desk.

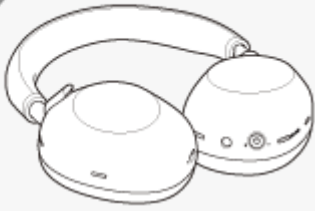

- When you wear the headset with your face up or down as shown below, or when you wear the headset upside down, wearing detection may not work properly, and the touch sensor control panel and NC/AMB (noise canceling/Ambient Sound Mode) button may not be available for operation. Wear the headset correctly while facing forward, or press the  (power) button briefly.
 - Wearing the headset while lying down or with your face up

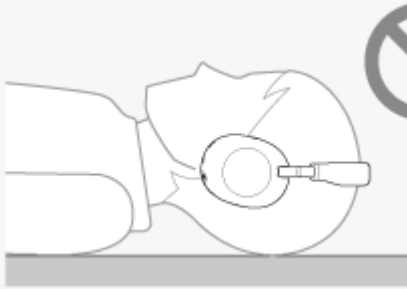

- Wearing the headset with your face down



- When you wear the headset over a cap, cloth, a scarf, hair, etc., wearing detection may not work properly, and the touch sensor control panel may not be available for operation. Wear the headset so that your ears are inside the earpads.
- When the supplied headphone cable is connected to the headset, wearing detection does not work.
- The wearing detection automatic music playback pause and resume function is only available when connected via Bluetooth connection.
- The connected device or playback application you are using may not support the wearing detection automatic music playback pause and resume function.
- External force beyond the range of normal use, such as turning the unit's rotary axis or other moving parts to the opposite side of the normal direction or dropping the headset, may cause damage. The warranty does not cover malfunctions caused by damage due to improper handling.

Related Topic

- [What you can do with the “Sony | Sound Connect” app](#)

Wireless Noise Canceling Stereo Headset
WH-1000XM6

About the touch sensor control panel

Use the touch sensor control panel (A) on the headset for various operations, such as music playback, phone calls, or switching to the Quick Attention Mode.



Main actions

- Tap twice quickly (with an interval of about 0.4 seconds between taps).

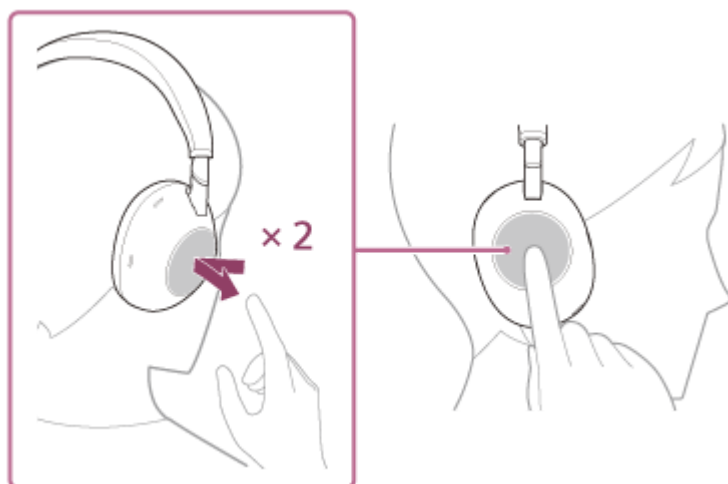

During music playback: Plays or pauses music.

For a phone call: Receives a call when there is an incoming call. Finishes the call during a call.

- Swipe forward and release.

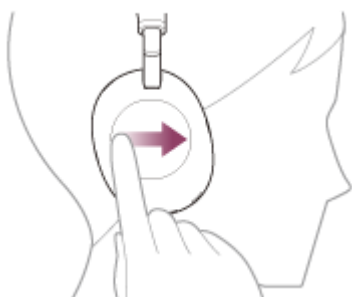

During music playback: Skips to the beginning of the next track. To fast-forward, swipe forward and hold. Release at the desired playback point.

- Swipe backward and release.

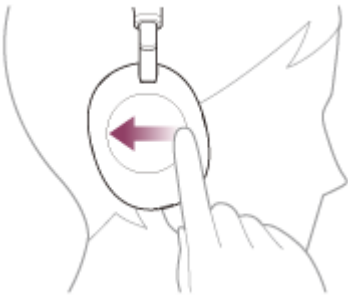

During music playback: Skips to the beginning of the previous track (or the current track during playback). To fast-reverse, swipe backward and hold. Release at the desired playback point.

- Swipe up and release.

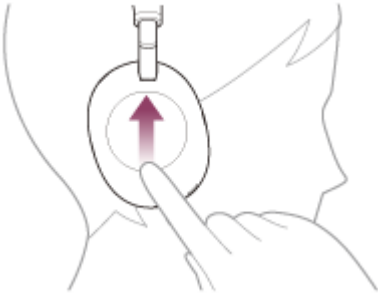

During music playback/a phone call: Increases the volume. Repeat until the volume reaches the desired level. To continue changing the volume, swipe up and hold. Release at the desired level.

- Swipe down and release.



During music playback/a phone call: Lowers the volume. Repeat until the volume reaches the desired level. To continue changing the volume, swipe down and hold. Release at the desired level.

- Hold your finger to the touch sensor control panel.

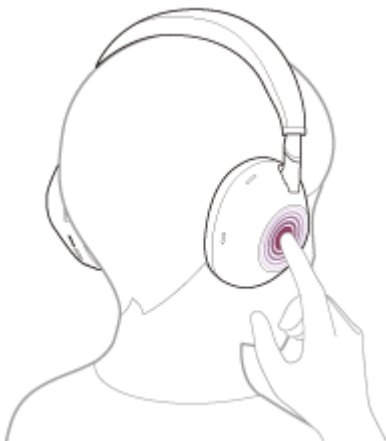

When using the voice assist function: Starts voice input. To finish voice input, release your finger.

- Touch the entire touch sensor control panel with your hand.

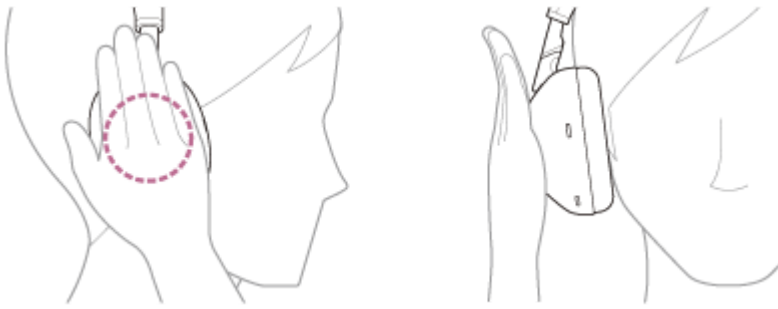

Activates the Quick Attention Mode. To deactivate the Quick Attention Mode, release your hand.

Hint

- You can switch the touch sensor control panel on/off, using the “Sony | Sound Connect” app.

Note

- If the communication condition is poor, the Bluetooth device may react incorrectly to the operation on the headset.
- The available functions may vary depending on the connected device, the music software, or app used. In some cases, it may operate differently or may not work even when the operations described above are performed.
- In order to prevent the headset from reacting incorrectly, music playback, making and receiving calls, and other operations cannot be performed when the headset is removed, even if you tap the touch sensor control panel.

Related Topic

- [What you can do with the “Sony | Sound Connect” app](#)
- [Controlling the audio device \(Bluetooth connection\)](#)
- [Functions for a phone call](#)
- [Wearing the headset](#)
- [Using Google Assistant](#)
- [Using the voice assist function \(Siri\)](#)
- [Listening to ambient sound quickly \(Quick Attention Mode\)](#)
- [Receiving a call](#)
- [Making a call](#)

Wireless Noise Canceling Stereo Headset
WH-1000XM6

Using Quick Access

Quick Access is a feature that allows you to play content in the corresponding app by simply pressing the button of the headset.

1 Put the headset on your ears.

See "[Wearing the headset](#)" for how to wear the headset on your ears.

2 Connect the headset to a smartphone via a Bluetooth connection.

3 Launch the "Sony | Sound Connect" app and set the NC/AMB (noise canceling/Ambient Sound Mode) button as the Quick Access button.

4 Using the "Sony | Sound Connect" app, assign a service to be performed when the NC/AMB (noise canceling/Ambient Sound Mode) button is pressed twice or 3 times.

When the NC/AMB (noise canceling/Ambient Sound Mode) button is pressed twice or 3 times, the service assigned beforehand can be performed.

Set the function performed when the NC/AMB (noise canceling/Ambient Sound Mode) button is pressed twice to [Press the [NC/AMB] button 2 times] and the function performed when the button is pressed 3 times to [Press the [NC/AMB] button 3 times].

5 Launch the app of the service assigned for Quick Access.

6 Press the NC/AMB (noise canceling/Ambient Sound Mode) button twice or 3 times to use Quick Access.

The service assigned beforehand is performed.

Hint

- To use Quick Access, you need to install the corresponding smartphone app and connect to the Internet. Some apps will require you to sign in.
- For details on the latest specifications of Quick Access, refer to the "Sony | Sound Connect" app.

Note

- The services that can be assigned to Quick Access differ depending on the countries and regions.

Wireless Noise Canceling Stereo Headset
WH-1000XM6

Charging the headset

The headset contains a built-in lithium-ion rechargeable battery. Use the supplied USB Type-C cable to charge the headset before use.

1 Connect the headset to an AC outlet.

Use the supplied USB Type-C cable and a commercially available USB AC adaptor (A).

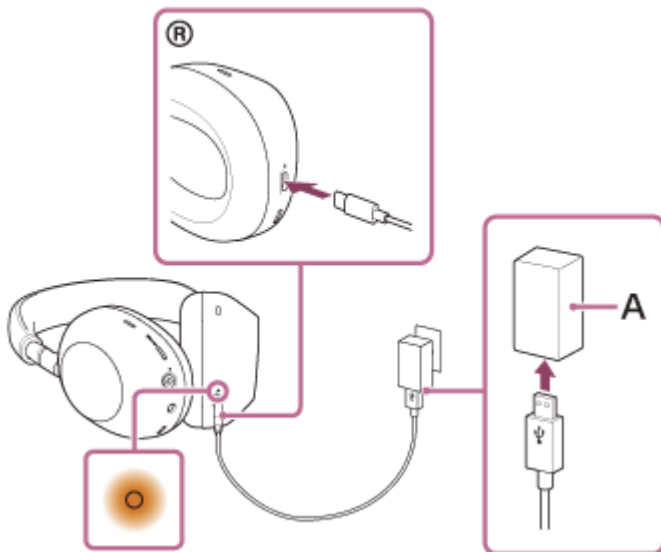

- The charging indicator (orange) of the headset lights up.
- Charging is completed in about 3.5 hours* and the charging indicator turns off automatically.

* Time required for charging the empty battery to its full capacity. The charging time may differ depending on the conditions of use.

After charging is complete, disconnect the USB Type-C cable.

About charging while using the headset

You can use the headset while charging.

When using the headset while it is charging, charging will stop at approximately 80% (if the battery level is more than 80%, charging will not start). The value is a rough estimate. The value may vary depending on the ambient environment. Depending on the charging environment (such as the power source or type of USB AC adaptor used), you may hear electrical noise from the headset when it is charging.

Headset functions and operations may not work correctly.

Charging when there is liquid such as water, sweat or foreign matter such as dust on the USB Type-C cable or USB Type-C port can cause accidents such as burns or serious injuries due to fire, electric shock, overheating, or ignition. Charging the headset in this manner can also cause malfunction. Note the following when using the headset while charging.

- If you feel any abnormalities, stop using the headset immediately.
- Check that there is no dust or foreign objects in the port.
- If the USB Type-C cable or USB Type-C port gets wet with liquid such as drinking water or sweat while charging, immediately disconnect the USB Type-C cable from the connected device and stop charging.



Water detection in the charging port

This function is available with headset software version Ver. 2.0.0 or later.

When the headset detects an abnormality, such as water droplets or foreign objects in the USB Type-C port, it will notify you via voice guidance and a notification on the "Sony | Sound Connect" app.

Do not connect the charger while an abnormality is detected.

Note the following.

- Make sure the USB Type-C port is clear of any foreign objects.
- If water droplets are present on the charging port, allow it to dry completely before charging.
- If foreign objects are found in the charging port, carefully remove them with a tool such as an air duster, being careful not to damage the port, and then try charging.

System requirements for battery charge using USB

USB AC adaptor

A commercially available USB AC adaptor capable of supplying an output current of 1.5 A or more

Commercially available USB AC adaptor compatible with USB PD (USB Power Delivery)

It is recommended to use a USB AC adaptor compatible with 5 V/2 A or 9 V/3 A output.

It is not guaranteed that the headset works with all USB PD compatible equipment.

Personal computer

Personal computer with a standard USB port

- We do not guarantee that the operating procedures will work on all computers.
- Operations using a custom-built or homebuilt computer are not guaranteed.

Hint

- The headset can be also charged by connecting the headset to a running computer using the supplied USB Type-C cable.

Note

- The battery does not fully charge when the headset is on.
- Charging may not be successful with cables other than the supplied USB Type-C cable.
- The water detection function may malfunction if you use cables other than the supplied USB Type-C cable.
- Charging may not be successful depending on the type of USB AC adaptor.
- The headset cannot be charged when the computer goes into standby (sleep) or hibernation mode. In this case, change the computer settings, and start charging once again.
- If the headset is not used for a long time, the rechargeable battery usage hours may be reduced. However, the battery hours will improve after several charge and discharge cycles. If you store the headset for a long time, charge the battery once every 6 months to avoid over-discharge.
- If the headset is not used for a long time, it may take longer to charge the battery.

- If the headset detects a problem while charging due to the following causes, the charging indicator (orange) flashes. In this case, charge once again within the charging temperature range. If the problem persists, consult the Sony support contact or your nearest Sony dealer.
 - Ambient temperature exceeds the charging temperature range of 5 °C - 35 °C (41 °F - 95 °F).
 - There is a problem with the rechargeable battery.
- If the headset is not used for a long time, the charging indicator (orange) may not immediately light up when the headset starts charging. Please wait a moment until the indicator lights up.
- If the usage hours of the built-in rechargeable battery decrease significantly, the battery should be replaced. Consult the Sony support contact or your nearest Sony dealer.
- Avoid exposure to extreme temperature changes, direct sunlight, moisture, sand, dust, and electrical shock. Never leave the headset in a parked vehicle.
- When connecting the headset to a computer, use only the supplied USB Type-C cable, and make sure to connect them directly. Charging will not be properly completed when the headset is connected through a USB hub.
- It is not guaranteed that the headset works with all USB PD compatible equipment.
- When the headset is charged using a USB PD compatible AC adaptor, the right unit may become hot, but this is not a malfunction.

Wireless Noise Canceling Stereo Headset
WH-1000XM6

Available operating time

The available operating times of the headset with the battery fully charged are as follows:

Bluetooth connection

Music playback time

Codec	Noise canceling function/Ambient Sound Mode	Available operating time
LDAC™	Noise canceling function: ON	Max. 26 hours
LDAC	Ambient Sound Mode: ON	Max. 26 hours
LDAC	OFF	Max. 36 hours
AAC	Noise canceling function: ON	Max. 30 hours
AAC	Ambient Sound Mode: ON	Max. 30 hours
AAC	OFF	Max. 40 hours
SBC	Noise canceling function: ON	Max. 30 hours
SBC	Ambient Sound Mode: ON	Max. 30 hours
SBC	OFF	Max. 40 hours
LC3	Noise canceling function: ON	Max. 30 hours
LC3	Ambient Sound Mode: ON	Max. 30 hours
LC3	OFF	Max. 40 hours

- About 1 hour* of music playback is possible after 3 minutes charging when using a commercially available USB AC adaptor with output of 5 V/1.5 A or more.
- About 3 hours* of music playback is possible after 3 minutes charging when using a commercially available USB PD compatible AC adaptor with output of 9 V/2.3 A or more.

* Time when used in a place with an ambient temperature between 25 °C and 35 °C (77 °F - 95 °F). It may differ depending on the conditions of use.

Communication time

Noise canceling function/Ambient Sound Mode	Available operating time
Noise canceling function: ON	Max. 24 hours
Ambient Sound Mode: ON	Max. 24 hours
OFF	Max. 28 hours

Headphone cable connected (power is turned on)

Noise canceling function/Ambient Sound Mode	Available operating time
Noise canceling function: ON	Max. 28 hours
Ambient Sound Mode: ON	Max. 28 hours
OFF	Max. 38 hours

Hint

- By using the “Sony | Sound Connect” app, you can check which codec is used for a connection or switch the DSEE Extreme™ function.

Note

- Usage hours may be different from the time described above depending on the settings for the headset functions and usage conditions.
- If you set the following functions, the available operating time of the battery becomes shorter than the ones described above.
 - Equalizer
 - DSEE Extreme
 - Speak-to-Chat
 - Service Link
 - Other changes to the default modes and functions made on the “Sony | Sound Connect” app

If you run the above settings at the same time, the available operating time of the battery becomes even shorter.

Related Topic

- [Supported codecs](#)
- [About the DSEE Extreme function](#)
- [What you can do with the “Sony | Sound Connect” app](#)

Wireless Noise Canceling Stereo Headset
WH-1000XM6

Checking the remaining battery charge

You can check the remaining battery charge of the rechargeable battery in the following ways.

When you are using an iPhone (iOS 13 or later)

When the headset is connected to an iPhone via an HFP (Hands-free Profile) Bluetooth connection, you can check the remaining battery charge of the headset on an iPhone. For details, refer to the operating instructions for the iPhone. The remaining charge which is displayed may differ from the actual remaining charge in some cases. Use it as a rough estimate.

When you are using an Android™ smartphone (OS 8.1 or later)

When the headset is connected to an Android smartphone via an HFP Bluetooth connection, you can check the remaining battery charge of the headset on the smartphone. For details, refer to the operating instructions for the Android smartphone.

The remaining charge which is displayed may differ from the actual remaining charge in some cases. Use it as a rough estimate.

Checking with the power button

When you press the  (power) button (A) while the headset is on, a voice guidance indicating the remaining battery charge can be heard.

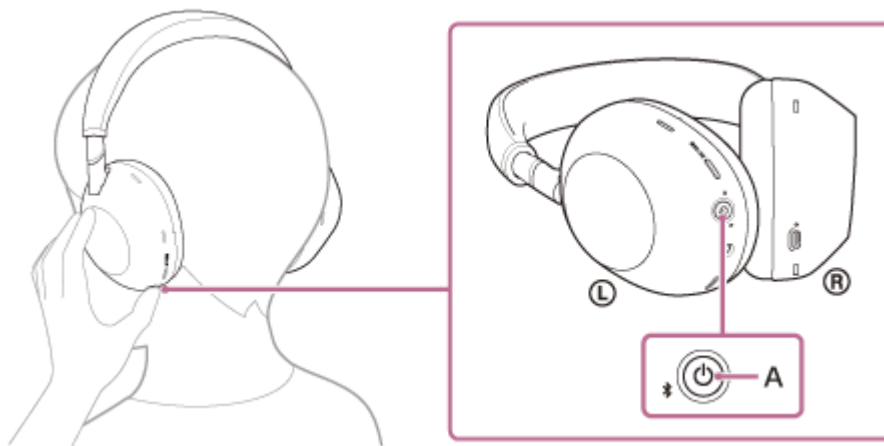

“Battery about XX %” (The “XX” value indicates the approximate remaining charge.)

“Battery fully charged”

The remaining battery charge indicated by the voice guidance may differ from the actual remaining charge in some cases. Use it as a rough estimate.

The indicator (orange) also flashes for about 15 seconds if the remaining battery charge is 10% or lower when the headset is turned on.

Notification with voice guidance

A warning beep sounds and the color of the operating indicator (blue) becomes orange. If you hear the voice guidance say, “Low battery”, charge the headset as soon as possible.

When the battery becomes completely empty, a warning beep sounds, the voice guidance say, “Battery is empty”, and the headset automatically turns off.

Hint

- You can also check the remaining battery charge of the headset with the “Sony | Sound Connect” app. Android smartphones and iPhone both support this app.

Note

- If the headset and smartphone are not connected with HFP, the remaining battery charge will not be correctly displayed.
- If you connect the headset to an iPhone or Android smartphone only with “Media audio” (A2DP) in a multipoint connection, the remaining battery charge will not be displayed correctly.
- The remaining battery charge may not be properly displayed immediately after a software update or if the headset has not been used for a long time. In this case, repeatedly charge and discharge the battery multiple times to properly display the remaining battery charge.

Related Topic

- [About the indicator](#)
- [What you can do with the “Sony | Sound Connect” app](#)

Wireless Noise Canceling Stereo Headset
WH-1000XM6

Turning on the headset

- 1 Press and hold the  (power) button (A) for about 2 seconds or more until the indicator (blue) flashes.

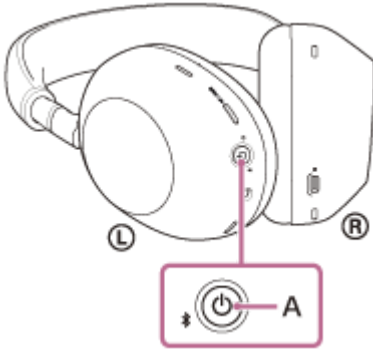

Related Topic

- [Turning off the headset](#)

Wireless Noise Canceling Stereo Headset
WH-1000XM6

Turning off the headset

- 1 Press and hold the  (power) button (A) for about 2 seconds or more until the indicator (blue) turns off.

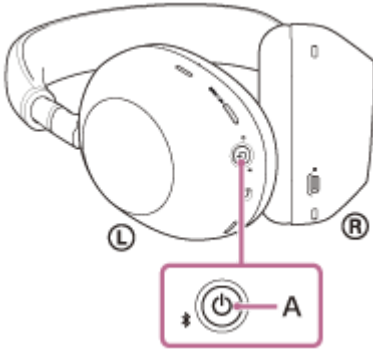

Hint

- You can also turn off the headset with the “Sony | Sound Connect” app.
- The headset will automatically turn off after 15 minutes of not being worn. This setting can be changed using the “Sony | Sound Connect” app.
- When storing the headset in a bag, etc., turn off the headset. Wearing detection may react incorrectly.

Related Topic

- [Turning on the headset](#)
- [What you can do with the “Sony | Sound Connect” app](#)

Wireless Noise Canceling Stereo Headset
WH-1000XM6

How to make a wireless connection to Bluetooth devices

You can enjoy music and hands-free calling with the headset wirelessly by using your Bluetooth device's Bluetooth function.

Pairing

To use the Bluetooth function, both of the connecting devices must be registered in advance. The operation to register a device is called "pairing".

Pair the headset and the device manually.

Connecting to a paired device

Once a device is paired, it is not necessary to pair it again. For devices already paired to the headset, follow the instructions for each device.

For details on pairing or connection operations, refer to the following Related Topic.

Related Topic

- [Pairing and connecting with an Android smartphone](#)
- [Pairing and connecting with an iPhone](#)
- [Pairing and connecting with a computer \(Windows® 11\)](#)
- [Pairing and connecting with a computer \(Windows 10\)](#)
- [Pairing and connecting with a computer \(Mac\)](#)
- [Pairing and connecting with a Bluetooth device](#)
- [Connecting to a paired Android smartphone](#)
- [Connecting to a paired iPhone](#)
- [Connecting to a paired computer \(Windows 11\)](#)
- [Connecting to a paired computer \(Windows 10\)](#)
- [Connecting to a paired computer \(Mac\)](#)
- [Connecting to a paired Bluetooth device](#)

Wireless Noise Canceling Stereo Headset
WH-1000XM6

Connecting with the “Sony | Sound Connect” app

Launch the “Sony | Sound Connect” app on your Android smartphone/iPhone to connect the headset to a smartphone or iPhone.



Sony Sound Connect 

Note

- The connection with some smartphones and iPhone devices may become unstable when connecting using the “Sony | Sound Connect” app. In that case, follow the procedures in [“Connecting to a paired Android smartphone”](#), or [“Connecting to a paired iPhone”](#) to connect to the headset.

Related Topic

- [Pairing and connecting with an Android smartphone](#)
- [Pairing and connecting with an iPhone](#)
- [Pairing and connecting with a computer \(Windows® 11\)](#)
- [Pairing and connecting with a computer \(Windows 10\)](#)
- [Pairing and connecting with a computer \(Mac\)](#)
- [Connecting to a paired Android smartphone](#)
- [Connecting to a paired iPhone](#)
- [What you can do with the “Sony | Sound Connect” app](#)
- [Installing the “Sony | Sound Connect” app](#)

Wireless Noise Canceling Stereo Headset
WH-1000XM6

Pairing and connecting with an Android smartphone

The operation to register the device that you wish to connect to is called “pairing”. First, pair a device to use it with the headset for the first time.

Before starting the operation, make sure of the following:

- The Android smartphone is placed within 1 m (3.2 ft) of the headset.
- The headset is charged sufficiently.
- The operating instructions for the Android smartphone is in hand.

1 Enter pairing mode on this headset.

Turn on the headset when you pair the headset with a device for the first time after you bought it or after you initialized the headset (the headset has no pairing information). The headset enters pairing mode automatically. In this case, proceed to step 2.

When you pair a second or subsequent Bluetooth device (the headset already has pairing information for other devices), press and hold the  (Bluetooth) button (A) for about 5 seconds or more to enter pairing mode manually.

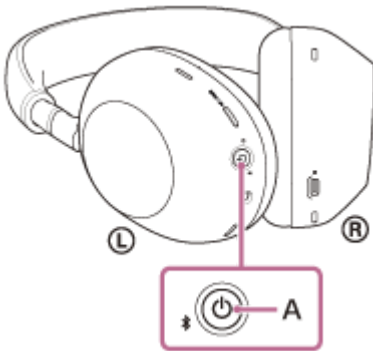

The indicator (blue) repeatedly flashes twice in a row. You will hear the voice guidance say, “Pairing”.

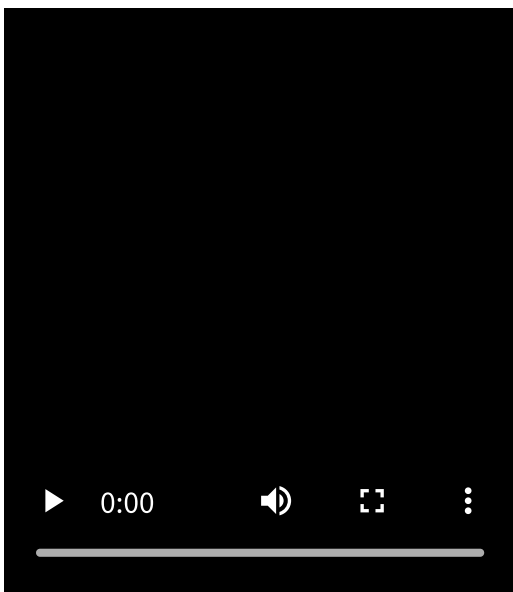

2 Unlock the screen of the Android smartphone if it is locked.

On your Android smartphone screen, select [Settings] - [Device connection] - [Bluetooth].



4 Touch the switch to turn on the Bluetooth function.

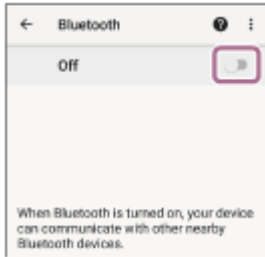

5 Touch [WH-1000XM6].

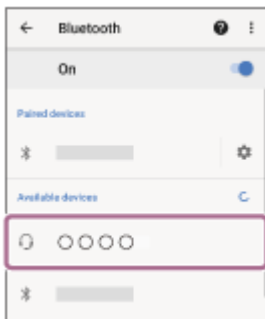

If Passkey* input is required, input "0000".

The headset and Android smartphone are paired and connected with each other.

You will hear a notification sound indicating that the connection is established.

If they are not connected, see "[Connecting to a paired Android smartphone](#)".

If [WH-1000XM6] does not appear on your Android smartphone screen, try again from step 3.

* A Passkey may be called "Passcode", "PIN code", "PIN number", or "Password".

Hint

- The operation above is an example. For more details, refer to the operating instructions supplied with the Android smartphone.
- To delete all Bluetooth pairing information, see "[Initializing the headset to restore factory settings](#)".

Note

- If pairing is not established within 5 minutes, pairing mode is canceled. In this case, turn off the power and start the operation again from step 1.
- Once Bluetooth devices are paired, there is no need to pair them again, except in the following cases:
 - Pairing information has been deleted after repair, etc.
 - When a 9th device is paired
The headset can be paired with up to 8 devices. If a new device is paired after 8 devices are already paired, the registration information of the paired device with the oldest connection date is overwritten with the information for the new device.
 - When the pairing information for the headset has been deleted from the connected Bluetooth device
 - When the headset is initialized
All of the pairing information will be deleted. In this case, delete the pairing information for the headset from the connected device and then pair them again.

- The headset can be paired with multiple devices, but can only play music from 1 paired device at a time.

Related Topic

- [How to make a wireless connection to Bluetooth devices](#)
- [Connecting to a paired Android smartphone](#)
- [Listening to music from a device via a Bluetooth connection](#)
- [Disconnecting Bluetooth connection \(after use\)](#)
- [Initializing the headset to restore factory settings](#)

5-063-141-11(5) Copyright 2025 Sony Corporation

Wireless Noise Canceling Stereo Headset
WH-1000XM6

Pairing and connecting with an Android smartphone using LE Audio

LE Audio is a sound communication standard for Bluetooth technology.

An LE Audio connection prioritizes low latency, resulting in a lower connection stability compared to a Classic Audio connection. If you experience sound stuttering due to poor reception, reconnect using Classic Audio.

Both the Android smartphone and the headset must support LE Audio.

- To connect to LE Audio, install the “Sony | Sound Connect” app on a smartphone that supports LE Audio, then connect the headset.
- Update the headset software and the “Sony | Sound Connect” app to the latest version.

Devices supporting LE Audio

For the latest information on compatible devices, refer to the following pages.

- Support page (For models of countries and regions excluding Chinese mainland)
- Sony | Sound Connect download page (For models of Chinese mainland)

About LE Audio

- LE Audio supports the “LC3” codec. When connection is established using LE Audio, you can enjoy sound from an Android smartphone with less sound delay.
- When connected using LE Audio, some of the headset functions cannot be used. For details, see [“What you can do with the “Sony | Sound Connect” app”](#).

1 Install the “Sony | Sound Connect” app on the Android smartphone, and connect the headset via Bluetooth connection.

For details on how to connect via Bluetooth connection, see [“Connecting with the “Sony | Sound Connect” app”](#) or [“Pairing and connecting with an Android smartphone”](#).

2 Set up with the “Sony | Sound Connect” app.

- For Xperia 1 IV/5 IV
Launch the “Sony | Sound Connect” app and select [Headphone connection setting] - [LE Audio Priority].
- For devices other than Xperia 1 IV/5 IV
Launch the “Sony | Sound Connect” app and select [BLUETOOTH CONNECTION QUALITY] - [Low latency].

3 On the Android smartphone, select [Settings] - [Device connection] - [Bluetooth].

4 Select [Paired devices] - [WH-1000XM6] and delete the pairing information (history of the Classic Audio connection).

5 Press and hold the (power) button for about 5 seconds to enter pairing mode.

The indicator (blue) repeatedly flashes twice in a row. You will hear the voice guidance say, “Pairing”.

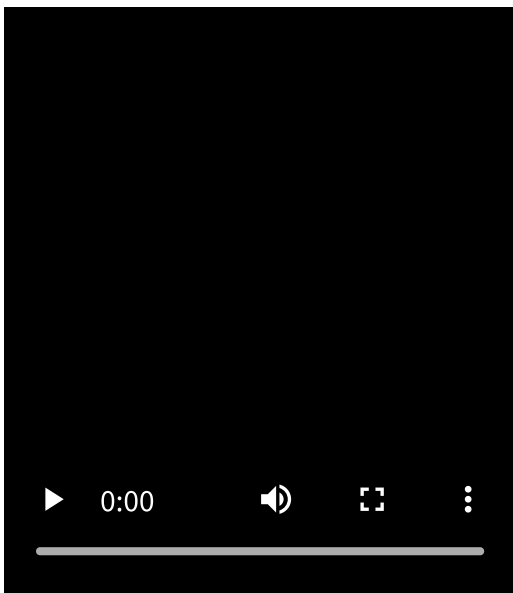

- 6 On the Android smartphone, select [Settings] - [Device connection] to open the Bluetooth settings screen.
- 7 Select [Pair new device].
- 8 Select [Available devices] - [WH-1000XM6].

The headset and Android smartphone are paired and connected with each other.
You will hear a notification sound indicating that the connection is established.
- 9 Touch  (settings) displayed next to the connected [WH-1000XM6].
- 10 Check that [LE Audio] is turned on.

If it is turned off, touch the switch to turn on [LE Audio].
- 11 On the “Sony | Sound Connect” app screen, check that [LE Audio] is displayed under the headset name.

To finish LE Audio

Reconnect the headset with the Android smartphone using Classic Audio.

- For Xperia 1 IV/5 IV
Launch the “Sony | Sound Connect” app and select [Headphone connection setting] - [Classic Audio only (conventional connection method)].
- For devices other than Xperia 1 IV/5 IV
Launch the “Sony | Sound Connect” app and select [BLUETOOTH CONNECTION QUALITY] - [Prioritize Sound Quality] or [Prioritize Stable Connection].

Hint

- The operation above is an example. For more details, refer to the operating instructions supplied with the Android smartphone.
- If sound stuttering occurs or the connection is unstable when connected using LE Audio, reconnect using Classic Audio.
- To connect using GMAP (Gaming Audio Profile)
 - GMAP is one of the LE Audio profiles that provides ultra-low latency that is ideal for gaming.
When connected to LE Audio, if you launch a gaming app that supports GMAP, the profile will automatically switch.

To connect using GMAP, the smartphone needs to be compatible with GMAP. For details about compatibility, refer to the operating instructions supplied with your smartphone.

Related Topic

- [Charging the headset](#)
- [How to make a wireless connection to Bluetooth devices](#)
- [Connecting to a paired Android smartphone](#)
- [Listening to music from a device via a Bluetooth connection](#)
- [Disconnecting Bluetooth connection \(after use\)](#)
- [Initializing the headset to restore factory settings](#)

5-063-141-11(5) Copyright 2025 Sony Corporation

Connecting to a paired Android smartphone

1 Unlock the screen of the Android smartphone if it is locked.

2 Turn on the headset.

Press and hold the  (power) button (A) for about 2 seconds or more.

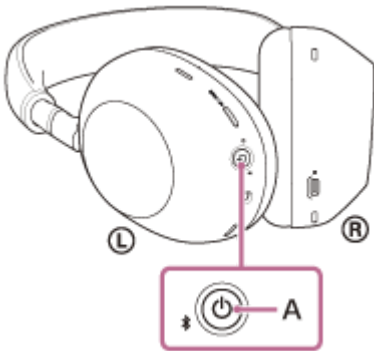

You will hear a notification sound indicating that the headset is turned on.

The indicator (blue) continues to flash even after you release your finger from the button.

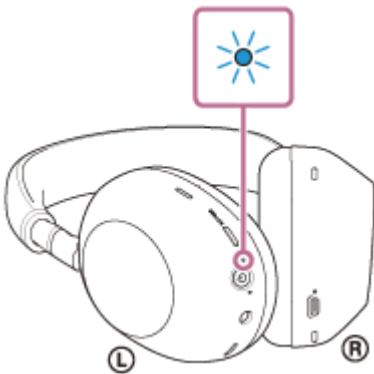

If the headset has automatically connected to the last connected device, you will hear a notification sound indicating that the connection is established.

Check the connection status on the Android smartphone. If it is not connected, proceed to step 3.

3 On your Android smartphone screen, select [Settings] - [Device connection] - [Bluetooth].



4 Touch the switch to turn on the Bluetooth function.

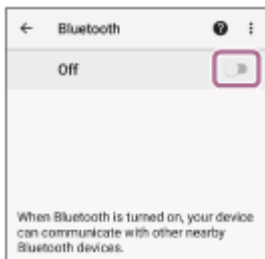

5 Touch [WH-1000XM6].

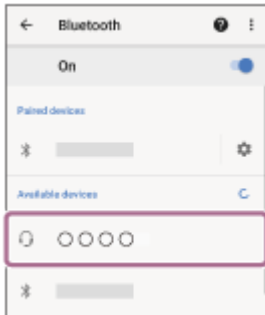

You will hear a notification sound indicating that the connection is established.

Hint

- The operation above is an example. For more details, refer to the operating instructions supplied with the Android smartphone.

Note

- When connecting, [WH-1000XM6], [LE_WH-1000XM6], or both may be displayed on the connecting device. When both or [WH-1000XM6] is displayed, select [WH-1000XM6]; when [LE_WH-1000XM6] is displayed, select [LE_WH-1000XM6].
- If the last-connected Bluetooth device is placed near the headset, the headset may connect automatically to the device by simply turning on the headset. If this is the case, deactivate the Bluetooth function on the last-connected device or turn off the power.
- If you cannot connect your Android smartphone to the headset, delete the headset pairing information on your smartphone and perform pairing again. As for the operations on your Android smartphone, refer to the operating instructions supplied with the smartphone.

Related Topic

- [How to make a wireless connection to Bluetooth devices](#)
- [Pairing and connecting with an Android smartphone](#)
- [Listening to music from a device via a Bluetooth connection](#)
- [Disconnecting Bluetooth connection \(after use\)](#)

Wireless Noise Canceling Stereo Headset
WH-1000XM6

Pairing and connecting with an iPhone

The operation to register the device that you wish to connect to is called “pairing”. First, pair a device to use it with the headset for the first time.

Before starting the operation, make sure of the following:

- The iPhone is placed within 1 m (3.2 ft) of the headset.
- The headset is charged sufficiently.
- The operating instructions for the iPhone is in hand.

1 Enter pairing mode on this headset.

Turn on the headset when you pair the headset with a device for the first time after you bought it or after you initialized the headset (the headset has no pairing information). The headset enters pairing mode automatically. In this case, proceed to step 2.

When you pair a second or subsequent Bluetooth device (the headset already has pairing information for other devices), press and hold the  (Bluetooth) button (A) for about 5 seconds or more to enter pairing mode manually.

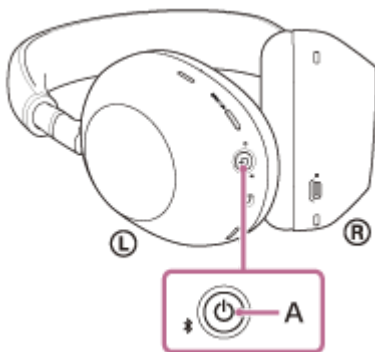

The indicator (blue) repeatedly flashes twice in a row. You will hear the voice guidance say, “Pairing”.

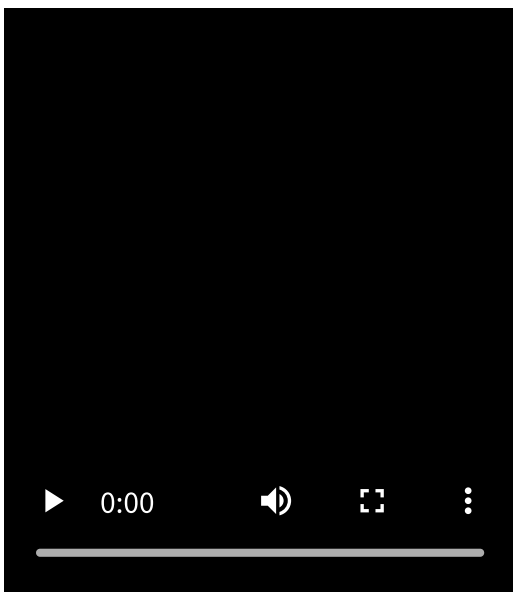

2 Unlock the screen of the iPhone if it is locked.

On your iPhone screen, go to [Settings] and touch [Bluetooth].

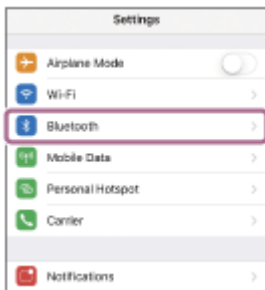

4 Touch the switch to turn on the Bluetooth function.



5 Touch [WH-1000XM6].

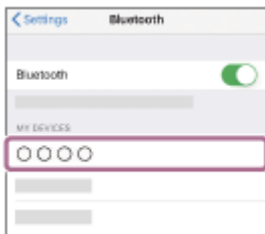

If Passkey* input is required, input "0000".

The headset and iPhone are paired and connected with each other.

You will hear a notification sound indicating that the connection is established.

If they are not connected, see "[Connecting to a paired iPhone](#)".

If [WH-1000XM6] does not appear on the display of the iPhone, try again from step 3.

* A Passkey may be called "Passcode", "PIN code", "PIN number", or "Password".

Hint

- The operation above is an example. For more details, refer to the operating instructions supplied with the iPhone.
- To delete all Bluetooth pairing information, see "[Initializing the headset to restore factory settings](#)".

Note

- If pairing is not established within 5 minutes, pairing mode is canceled. In this case, turn off the power and start the operation again from step 1.
- Once Bluetooth devices are paired, there is no need to pair them again, except in the following cases:
 - Pairing information has been deleted after repair, etc.
 - When a 9th device is paired
The headset can be paired with up to 8 devices. If a new device is paired after 8 devices are already paired, the registration information of the paired device with the oldest connection date is overwritten with the information for the new device.
 - When the pairing information for the headset has been deleted from the connected Bluetooth device
 - When the headset is initialized
All of the pairing information will be deleted. In this case, delete the pairing information for the headset from the connected device and then pair them again.

- The headset can be paired with multiple devices, but can only play music from 1 paired device at a time.

Related Topic

- [How to make a wireless connection to Bluetooth devices](#)
- [Connecting to a paired iPhone](#)
- [Listening to music from a device via a Bluetooth connection](#)
- [Disconnecting Bluetooth connection \(after use\)](#)
- [Initializing the headset to restore factory settings](#)

5-063-141-11(5) Copyright 2025 Sony Corporation

Connecting to a paired iPhone

1 Unlock the screen of the iPhone if it is locked.

2 Turn on the headset.

Press and hold the  (power) button (A) for about 2 seconds or more.

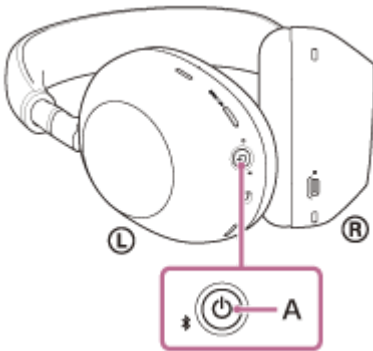

You will hear a notification sound indicating that the headset is turned on.

The indicator (blue) continues to flash even after you release your finger from the button.

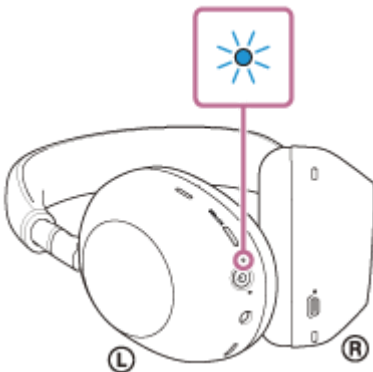

If the headset has automatically connected to the last connected device, you will hear a notification sound indicating that the connection is established.

Check the connection status on the iPhone. If it is not connected, proceed to step 3.

3 On your iPhone screen, go to [Settings] and touch [Bluetooth].

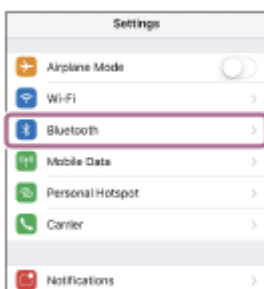

4 Touch the switch to turn on the Bluetooth function.



5 Touch [WH-1000XM6].

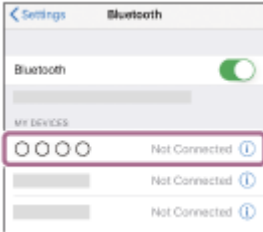

You will hear a notification sound indicating that the connection is established.

Hint

- The operation above is an example. For more details, refer to the operating instructions supplied with the iPhone.

Note

- When connecting, [WH-1000XM6], [LE_WH-1000XM6], or both may be displayed on the connecting device. When both or [WH-1000XM6] is displayed, select [WH-1000XM6]; when [LE_WH-1000XM6] is displayed, select [LE_WH-1000XM6].
- If the last-connected Bluetooth device is placed near the headset, the headset may connect automatically to the device by simply turning on the headset. If this is the case, deactivate the Bluetooth function on the last-connected device or turn off the power.
- If you cannot connect your iPhone to the headset, delete the headset pairing information on your iPhone and perform pairing again. As for the operations on your iPhone, refer to the operating instructions supplied with the iPhone.

Related Topic

- [How to make a wireless connection to Bluetooth devices](#)
- [Pairing and connecting with an iPhone](#)
- [Listening to music from a device via a Bluetooth connection](#)
- [Disconnecting Bluetooth connection \(after use\)](#)

Wireless Noise Canceling Stereo Headset
WH-1000XM6

Pairing and connecting with a computer (Windows® 11)

The operation to register the device that you wish to connect to is called “pairing”. First, pair a device to use it with the headset for the first time.

Before starting the operation, make sure of the following:

- Your computer has a Bluetooth function that supports music playback connections (A2DP).
- When you use a video calling application on your computer, your computer has a Bluetooth function that supports calling connections (HFP/HSP).
- The computer is placed within 1 m (3.2 ft) of the headset.
- The headset is charged sufficiently.
- The operating instructions for the computer is in hand.
- Depending on the computer you are using, the built-in Bluetooth adaptor may need to be turned on. If you do not know how to turn on the Bluetooth adaptor or are unsure if your computer has a built-in Bluetooth adaptor, refer to the operating instructions supplied with the computer.
- The Swift Pair function makes pairing easier. To use the Swift Pair function, click the [Start] button - [Settings] - [Bluetooth & devices] - [Show notifications to connect using Swift Pair] switch to turn on the Swift Pair function.

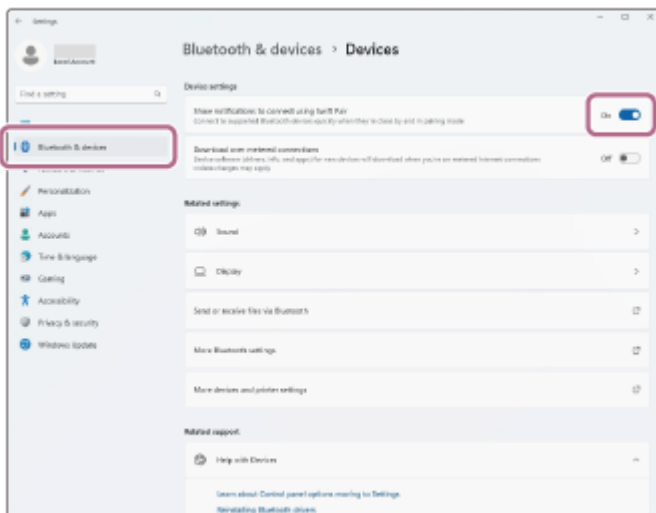

1 Enter pairing mode on this headset.

Turn on the headset when you pair the headset with a device for the first time after you bought it or after you initialized the headset (the headset has no pairing information). The headset enters pairing mode automatically. In this case, proceed to step 2.

When you pair a second or subsequent Bluetooth device (the headset already has pairing information for other devices), press and hold the  (Bluetooth) button (A) for about 5 seconds or more to enter pairing mode manually.

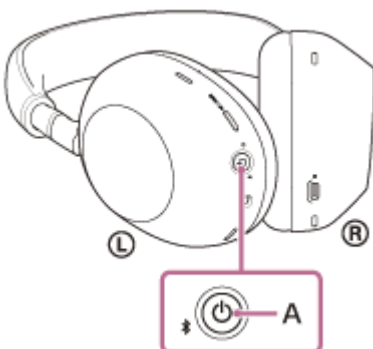

The indicator (blue) repeatedly flashes twice in a row. You will hear the voice guidance say, "Pairing".

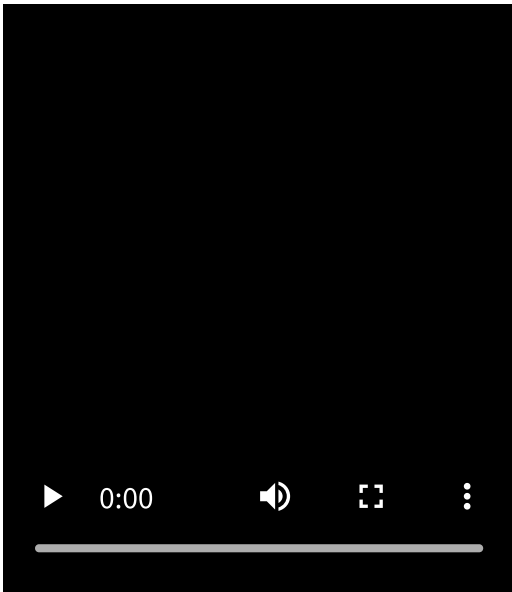

2 Wake the computer up if the computer is in standby (sleep) or hibernation mode.

To use the Swift Pair function, proceed to step 3.

To connect without using the Swift Pair function, proceed to step 4 and continue to step 8.

**3 (If you selected "To use the Swift Pair function" in step 2)
Select [Connect] from the pop-up menu displayed on your computer screen.**

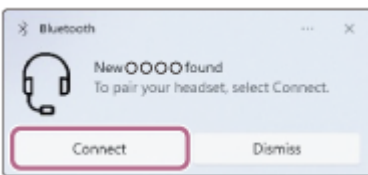

The connection is established.

You will hear a notification sound indicating that the connection is established.

**4 (If you selected "To connect without using the Swift Pair function" in step 2)
On your computer screen, click the [Start] button, then [Settings].**

5 Click [Bluetooth & devices].

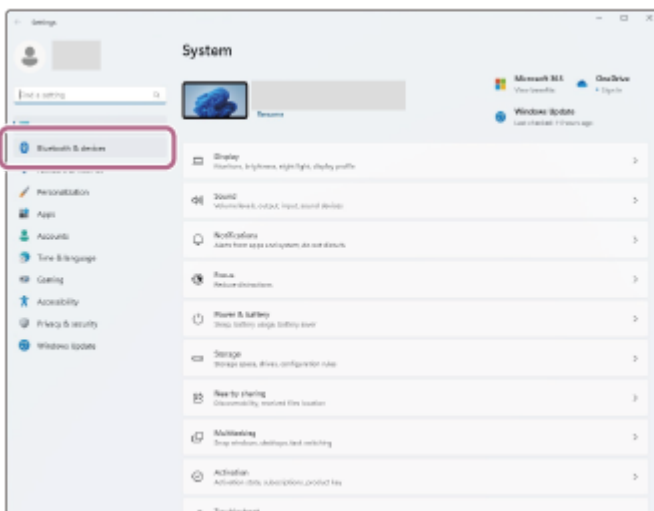

6 Click the [Bluetooth] switch to turn on the Bluetooth function, then click [Add device].

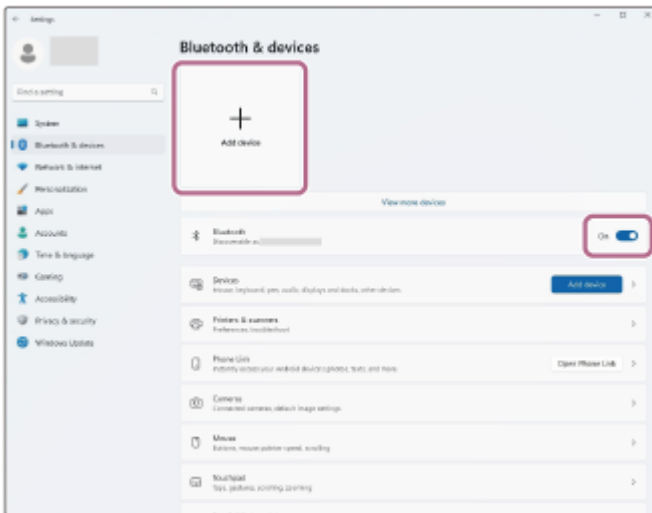

7 Click [Bluetooth].



8 Click [WH-1000XM6].



If Passkey* input is required, input "0000".

The headset and computer are paired and connected with each other.

You will hear a notification sound indicating that the connection is established.

If they are not connected, see [“Connecting to a paired computer \(Windows 11\)”](#).

If [WH-1000XM6] does not appear on your computer screen, try again from step 4.

* A Passkey may be called “Passcode”, “PIN code”, “PIN number”, or “Password”.

Hint

- The operation above is an example. For more details, refer to the operating instructions supplied with the computer.
- To delete all Bluetooth pairing information, see [“Initializing the headset to restore factory settings”](#).

Note

- If pairing is not established within 5 minutes, pairing mode is canceled. In this case, turn off the power and start the operation again from step 1.
- Once Bluetooth devices are paired, there is no need to pair them again, except in the following cases:
 - Pairing information has been deleted after repair, etc.
 - When a 9th device is paired
The headset can be paired with up to 8 devices. If a new device is paired after 8 devices are already paired, the registration information of the paired device with the oldest connection date is overwritten with the information for the new device.
 - When the pairing information for the headset has been deleted from the connected Bluetooth device
 - When the headset is initialized
All of the pairing information will be deleted. In this case, delete the pairing information for the headset from the connected device and then pair them again.
- The headset can be paired with multiple devices, but can only play music from 1 paired device at a time.

Related Topic

- [How to make a wireless connection to Bluetooth devices](#)
- [Connecting to a paired computer \(Windows 11\)](#)
- [Listening to music from a device via a Bluetooth connection](#)
- [Making a video call on your computer](#)
- [Disconnecting Bluetooth connection \(after use\)](#)
- [Initializing the headset to restore factory settings](#)

Wireless Noise Canceling Stereo Headset
WH-1000XM6

Pairing and connecting with a computer (Windows 10)

The operation to register the device that you wish to connect to is called “pairing”. First, pair a device to use it with the headset for the first time.

Before starting the operation, make sure of the following:

- Your computer has a Bluetooth function that supports music playback connections (A2DP).
- When you use a video calling application on your computer, your computer has a Bluetooth function that supports calling connections (HFP/HSP).
- The computer is placed within 1 m (3.2 ft) of the headset.
- The headset is charged sufficiently.
- The operating instructions for the computer is in hand.
- Depending on the computer you are using, the built-in Bluetooth adaptor may need to be turned on. If you do not know how to turn on the Bluetooth adaptor or are unsure if your computer has a built-in Bluetooth adaptor, refer to the operating instructions supplied with the computer.
- If your OS version is Windows 10 version 1803 or later, the Swift Pair function can be used to make pairing easier. To use the Swift Pair function, click the [Start] button - [Settings] - [Devices] - [Bluetooth & other devices], and check the [Show notifications to connect using Swift Pair] checkbox.

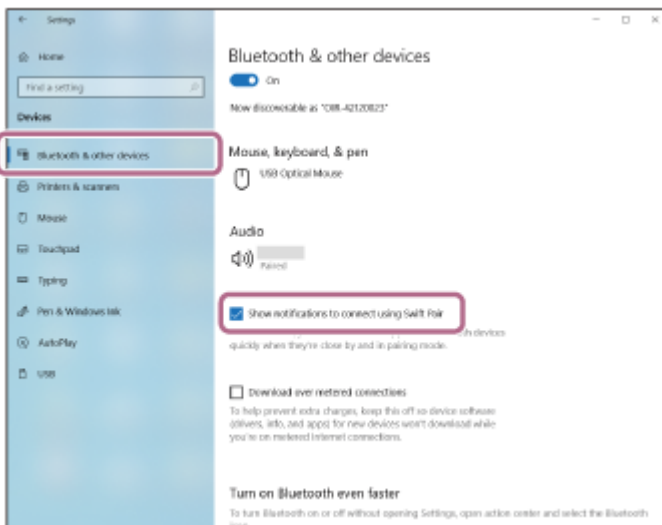

1 Enter pairing mode on this headset.

Turn on the headset when you pair the headset with a device for the first time after you bought it or after you initialized the headset (the headset has no pairing information). The headset enters pairing mode automatically. In this case, proceed to step 2.

When you pair a second or subsequent Bluetooth device (the headset already has pairing information for other devices), press and hold the  (Bluetooth) button (A) for about 5 seconds or more to enter pairing mode manually.

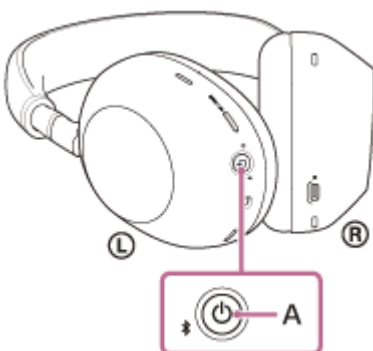

The indicator (blue) repeatedly flashes twice in a row. You will hear the voice guidance say, "Pairing".

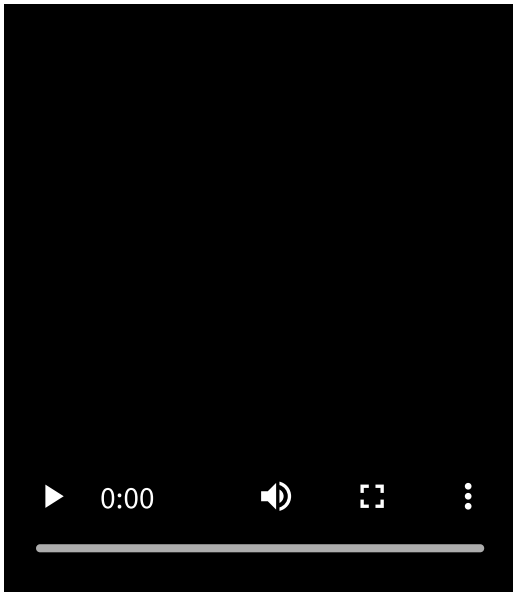

2 Wake the computer up if the computer is in standby (sleep) or hibernation mode.

To use the Swift Pair function, proceed to step 3.

To connect without using the Swift Pair function, proceed to step 4 and continue to step 7.

3 (If you selected "To use the Swift Pair function" in step 2)

Select [Connect] from the pop-up menu displayed on your computer screen.

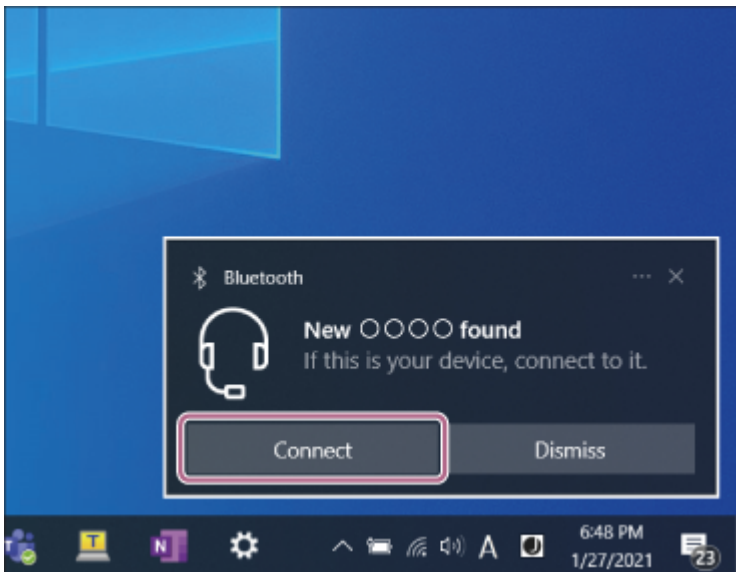

The connection is established.

You will hear a notification sound indicating that the connection is established.

4 (If you selected "To connect without using the Swift Pair function" in step 2)

On your computer screen, click the [Start] button, then click [Settings] - [Devices].

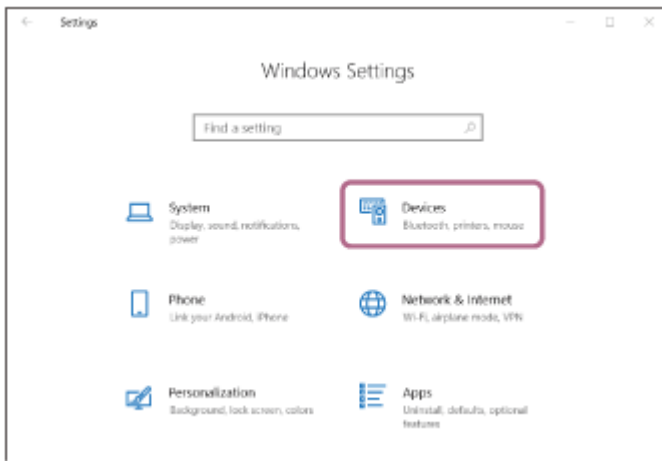

5 Click the [Bluetooth & other devices] tab, click the [Bluetooth] switch to turn on the Bluetooth function, then click [Add Bluetooth or other device].

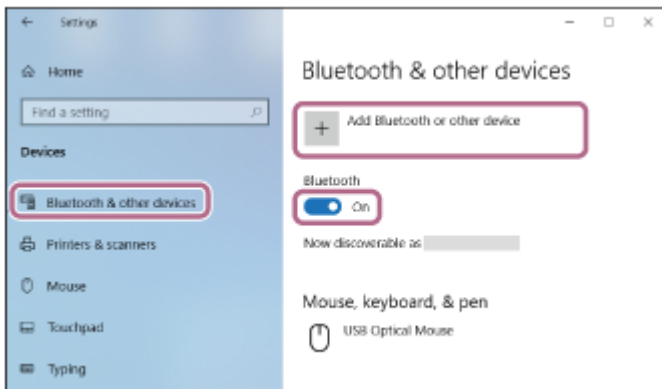

6 Click [Bluetooth].

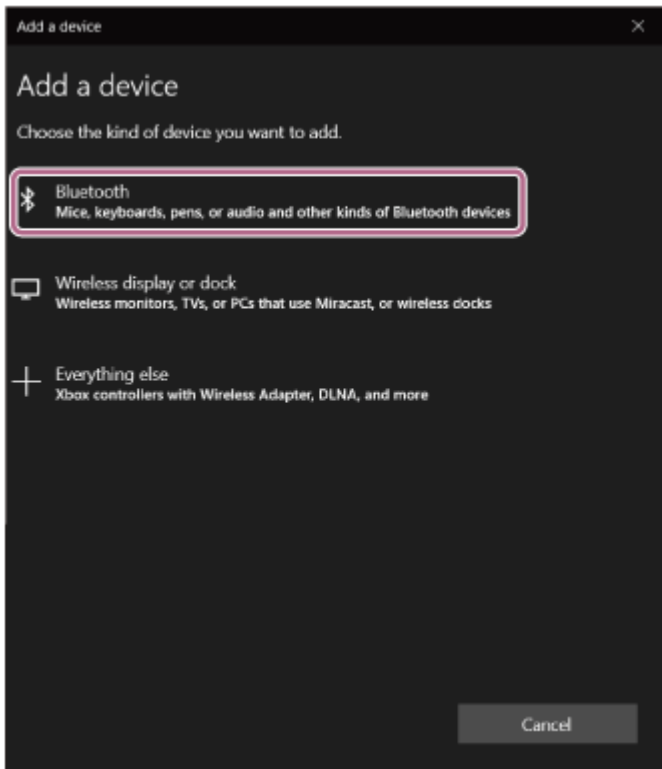

7 Click [WH-1000XM6].

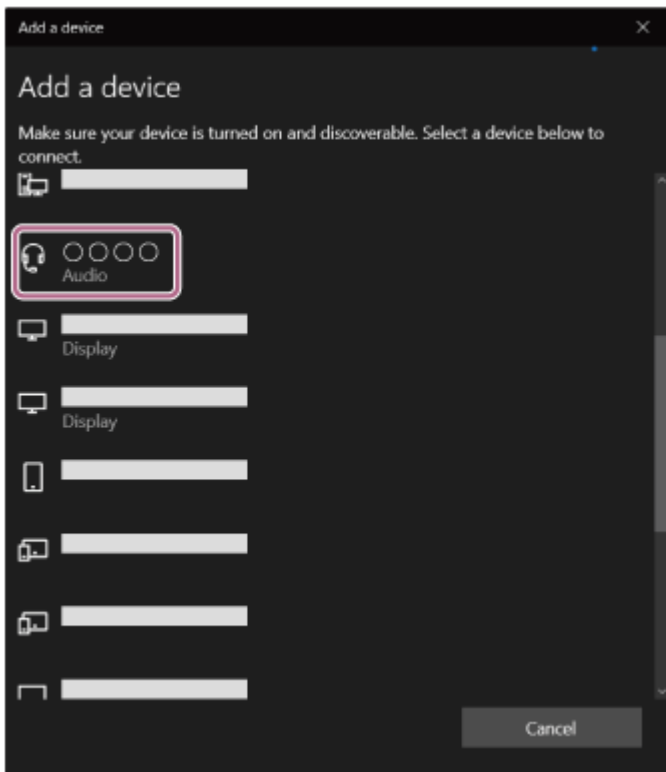

If Passkey* input is required, input “0000”.

The headset and computer are paired and connected with each other.

You will hear a notification sound indicating that the connection is established.

If they are not connected, see [“Connecting to a paired computer \(Windows 10\)”](#).

If [WH-1000XM6] does not appear on your computer screen, try again from step 4.

* A Passkey may be called “Passcode”, “PIN code”, “PIN number”, or “Password”.

Hint

- The operation above is an example. For more details, refer to the operating instructions supplied with the computer.
- To delete all Bluetooth pairing information, see [“Initializing the headset to restore factory settings”](#).

Note

- If pairing is not established within 5 minutes, pairing mode is canceled. In this case, turn off the power and start the operation again from step 1.
- Once Bluetooth devices are paired, there is no need to pair them again, except in the following cases:
 - Pairing information has been deleted after repair, etc.
 - When a 9th device is paired
The headset can be paired with up to 8 devices. If a new device is paired after 8 devices are already paired, the registration information of the paired device with the oldest connection date is overwritten with the information for the new device.
 - When the pairing information for the headset has been deleted from the connected Bluetooth device
 - When the headset is initialized
All of the pairing information will be deleted. In this case, delete the pairing information for the headset from the connected device and then pair them again.
- The headset can be paired with multiple devices, but can only play music from 1 paired device at a time.

Related Topic

- [How to make a wireless connection to Bluetooth devices](#)
- [Connecting to a paired computer \(Windows 10\)](#)

- Listening to music from a device via a Bluetooth connection
- Making a video call on your computer
- Disconnecting Bluetooth connection (after use)
- Initializing the headset to restore factory settings

5-063-141-11(5) Copyright 2025 Sony Corporation

Wireless Noise Canceling Stereo Headset
WH-1000XM6

Pairing and connecting with a computer (Mac)

The operation to register the device that you wish to connect to is called “pairing”. First, pair a device to use it with the headset for the first time.

Compatible OS

macOS (version 11 or later)

Before starting the operation, make sure of the following:

- Your computer has a Bluetooth function that supports music playback connections (A2DP).
- When you use a video calling application on your computer, your computer has a Bluetooth function that supports calling connections (HFP/HSP).
- The computer is placed within 1 m (3.2 ft) of the headset.
- The headset is charged sufficiently.
- The operating instructions for the computer is in hand.
- Depending on the computer you are using, the built-in Bluetooth adaptor may need to be turned on. If you do not know how to turn on the Bluetooth adaptor or are unsure if your computer has a built-in Bluetooth adaptor, refer to the operating instructions supplied with the computer.
- Set the computer speaker to the ON mode.

If the computer speaker is set to the  “OFF” mode, no sound can be heard from the headset.

Computer speaker in the ON mode



1 Enter pairing mode on this headset.

Turn on the headset when you pair the headset with a device for the first time after you bought it or after you initialized the headset (the headset has no pairing information). The headset enters pairing mode automatically. In this case, proceed to step 2.

When you pair a second or subsequent Bluetooth device (the headset already has pairing information for other devices), press and hold the  (Bluetooth) button (A) for about 5 seconds or more to enter pairing mode manually.

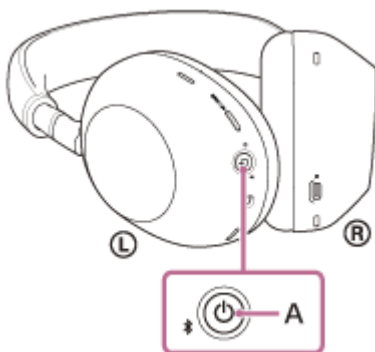

The indicator (blue) repeatedly flashes twice in a row. You will hear the voice guidance say, “Pairing”.

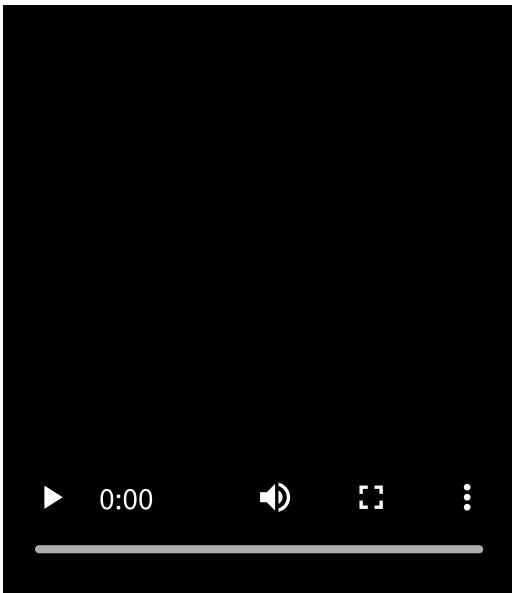

2 Wake the computer up if the computer is in standby (sleep) or hibernation mode.

3 Select [ (System Preferences)] - [Bluetooth] from the Dock at the bottom of your computer screen.



4 Select [WH-100XM6] on the [Bluetooth] screen and click [Connect].



If Passkey* input is required, input "0000".

The headset and computer are paired and connected with each other.

You will hear a notification sound indicating that the connection is established.

If they are not connected, see "[Connecting to a paired computer \(Mac\)](#)".

If [WH-100XM6] does not appear on your computer screen, try again from step 3.

* A Passkey may be called "Passcode", "PIN code", "PIN number", or "Password".

Hint

- The operation above is an example. For more details, refer to the operating instructions supplied with the computer.
- To delete all Bluetooth pairing information, see [“Initializing the headset to restore factory settings”](#).

Note

- If pairing is not established within 5 minutes, pairing mode is canceled. In this case, turn off the power and start the operation again from step 1.
- Once Bluetooth devices are paired, there is no need to pair them again, except in the following cases:
 - Pairing information has been deleted after repair, etc.
 - When a 9th device is paired
The headset can be paired with up to 8 devices. If a new device is paired after 8 devices are already paired, the registration information of the paired device with the oldest connection date is overwritten with the information for the new device.
 - When the pairing information for the headset has been deleted from the connected Bluetooth device
 - When the headset is initialized
All of the pairing information will be deleted. In this case, delete the pairing information for the headset from the connected device and then pair them again.
- The headset can be paired with multiple devices, but can only play music from 1 paired device at a time.

Related Topic

- [How to make a wireless connection to Bluetooth devices](#)
- [Connecting to a paired computer \(Mac\)](#)
- [Listening to music from a device via a Bluetooth connection](#)
- [Making a video call on your computer](#)
- [Disconnecting Bluetooth connection \(after use\)](#)
- [Initializing the headset to restore factory settings](#)

Wireless Noise Canceling Stereo Headset
WH-1000XM6

Connecting to a paired computer (Windows 11)

Before starting the operation, make sure of the following:

- Depending on the computer you are using, the built-in Bluetooth adaptor may need to be turned on. If you do not know how to turn on the Bluetooth adaptor or are unsure if your computer has a built-in Bluetooth adaptor, refer to the operating instructions supplied with the computer.

1 Wake the computer up if the computer is in standby (sleep) or hibernation mode.

2 Turn on the headset.

Press and hold the  (power) button (A) for about 2 seconds or more.

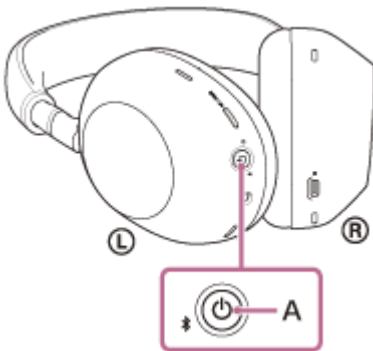

You will hear a notification sound indicating that the headset is turned on.

The indicator (blue) continues to flash even after you release your finger from the button.

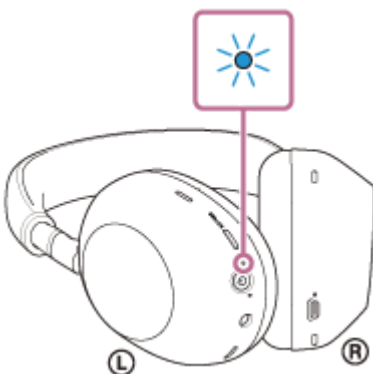

If the headset has automatically connected to the last connected device, you will hear a notification sound indicating that the connection is established.

Check the connection status on the computer. If it is not connected, proceed to step 3.

3 On your computer screen, right-click the speaker icon on the toolbar, then select [Sound settings].

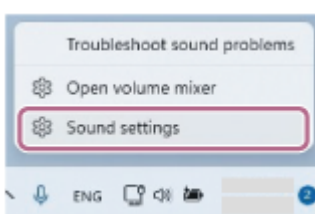

- 4 On the [Sound] screen, select [WH-1000XM6] for [Output] and [Input].

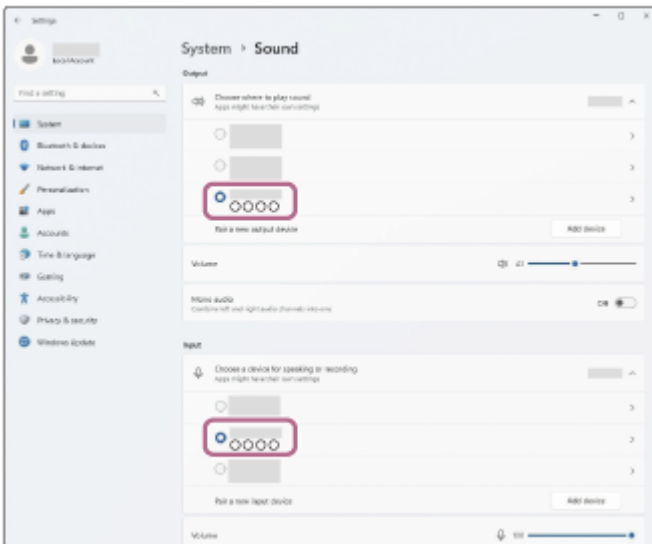

The connection is established.

You will hear a notification sound indicating that the connection is established. If [WH-1000XM6] is not displayed for [Output] and [Input], proceed to step 5.

- 5 Click [More sound settings].

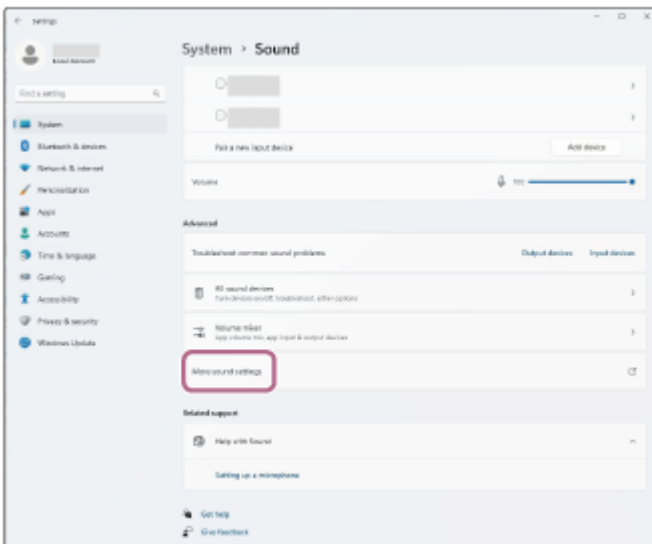

- 6 On the [Playback] tab on the [Sound] screen, select [WH-1000XM6], right-click it, and select [Connect] from the displayed menu.

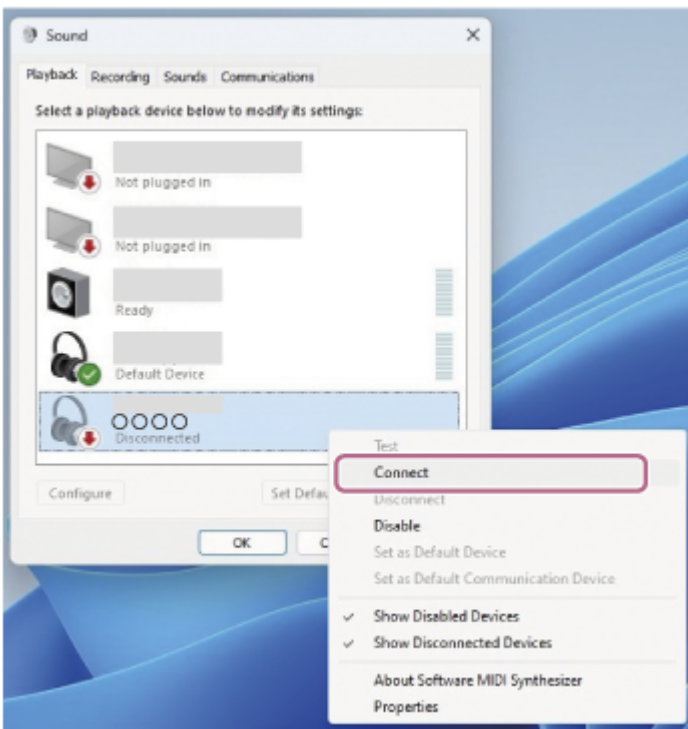

The connection is established.

You will hear a notification sound indicating that the connection is established.

7 On the [Recording] tab, select [WH-1000XM6], right-click it, and select [Connect] from the displayed menu.

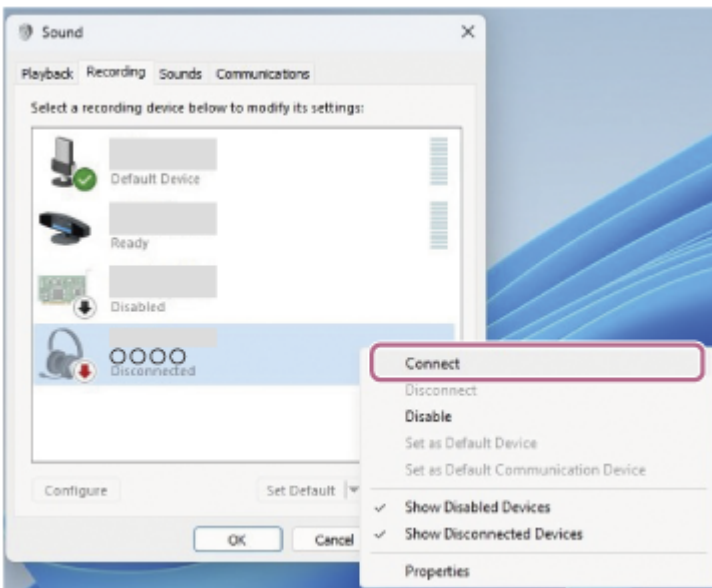

Hint

- The operation above is an example. For more details, refer to the operating instructions supplied with the computer.

Note

- If the music playback sound quality is poor, check that the A2DP function which supports music playback connections is enabled in the computer settings. For more details, refer to the operating instructions supplied with the computer.
- If the last-connected Bluetooth device is placed near the headset, the headset may connect automatically to the device by simply turning on the headset. If this is the case, deactivate the Bluetooth function on the last-connected device or turn off the power.

- If you cannot connect your computer to the headset, delete the headset pairing information on your computer and perform pairing again. For the operating procedures on your computer, refer to the operating instructions supplied with the computer.

Related Topic

- [How to make a wireless connection to Bluetooth devices](#)
- [Pairing and connecting with a computer \(Windows® 11\)](#)
- [Listening to music from a device via a Bluetooth connection](#)
- [Disconnecting Bluetooth connection \(after use\)](#)

5-063-141-11(5) Copyright 2025 Sony Corporation

Wireless Noise Canceling Stereo Headset
WH-1000XM6

Connecting to a paired computer (Windows 10)

Before starting the operation, make sure of the following:

- Depending on the computer you are using, the built-in Bluetooth adaptor may need to be turned on. If you do not know how to turn on the Bluetooth adaptor or are unsure if your computer has a built-in Bluetooth adaptor, refer to the operating instructions supplied with the computer.

1 Wake the computer up if the computer is in standby (sleep) or hibernation mode.

2 Turn on the headset.

Press and hold the  (power) button (A) for about 2 seconds or more.

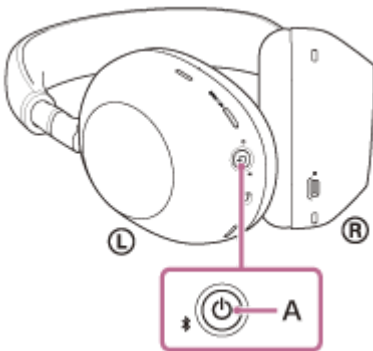

You will hear a notification sound indicating that the headset is turned on.

The indicator (blue) continues to flash even after you release your finger from the button.

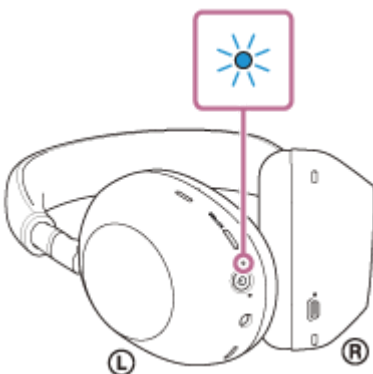

If the headset has automatically connected to the last connected device, you will hear a notification sound indicating that the connection is established.

Check the connection status on the computer. If it is not connected, proceed to step 3.

3 On your computer screen, right-click the speaker icon on the toolbar, then select [Open Sound settings].

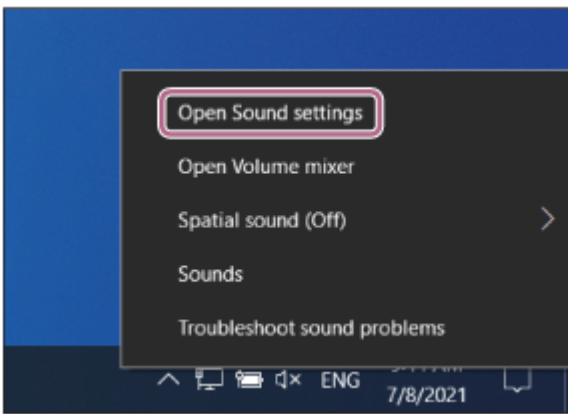

- 4 From the [Choose your output device] drop-down menu, select [Headphones (WH-1000XM6 Stereo)].

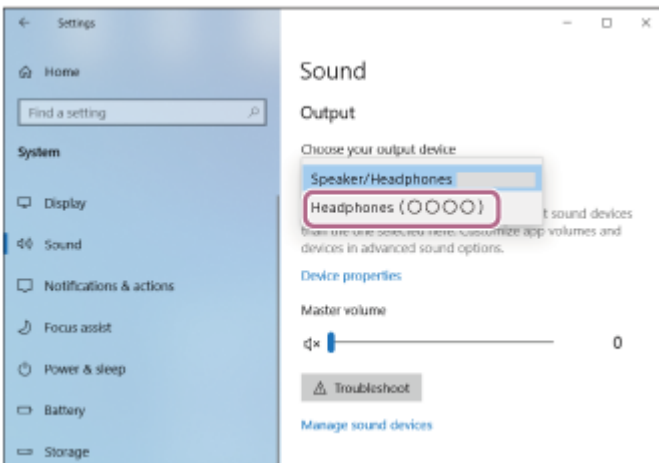

You will hear a notification sound indicating that the connection is established.

If [Headphones (WH-1000XM6 Stereo)] is not displayed on the drop-down menu, proceed to step 5.

- 5 Click [Sound Control Panel], right-click on the [Playback] tab on the [Sound] screen, and check the [Show Disconnected Devices] checkbox.

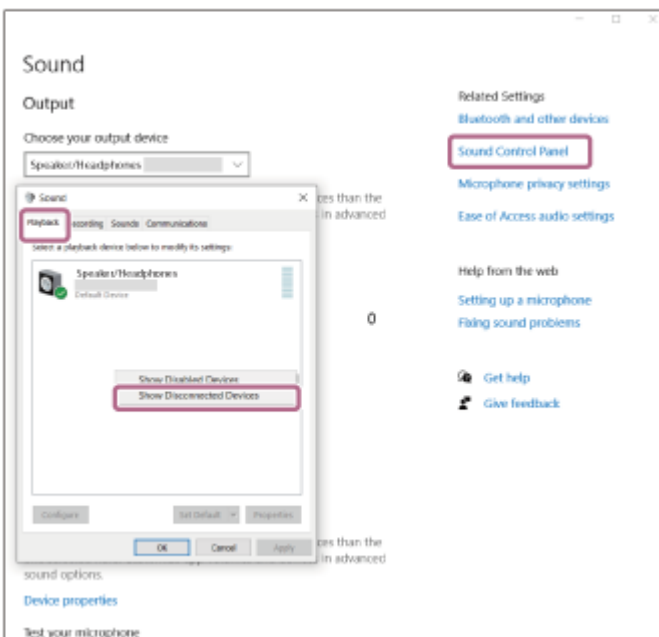

- 6 Select [Connect] from the displayed menu.

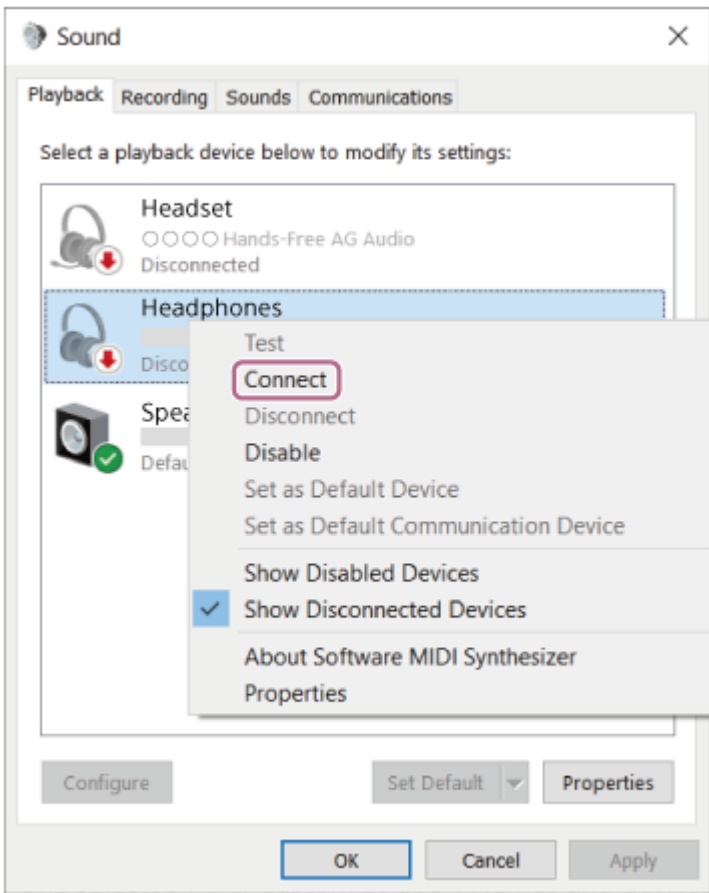

You will hear a notification sound indicating that the connection is established.

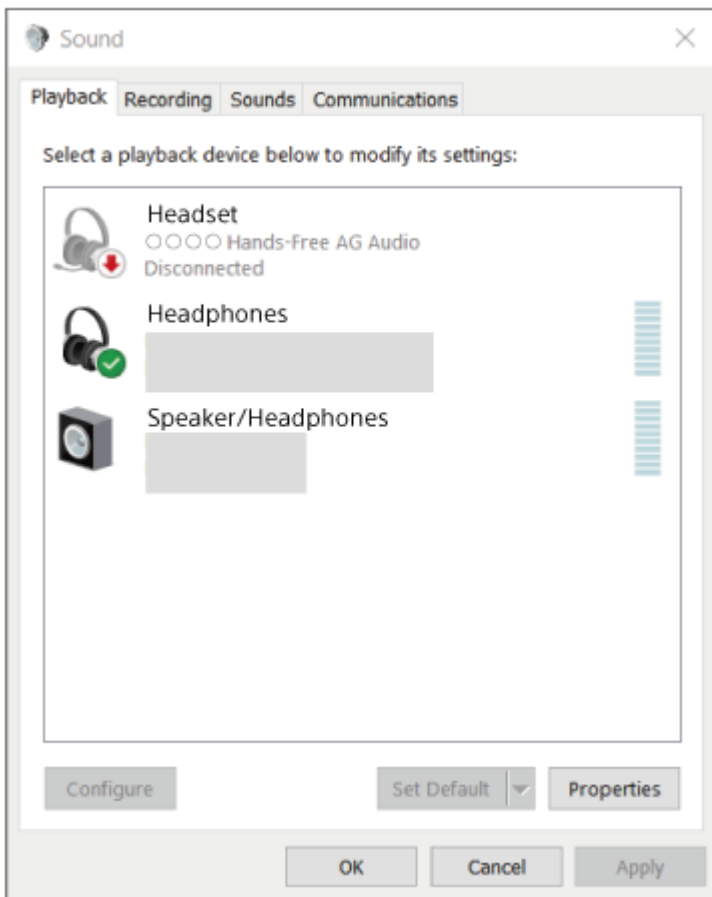

Hint

- The operation above is an example. For more details, refer to the operating instructions supplied with the computer.

Note

- If the music playback sound quality is poor, check that the A2DP function which supports music playback connections is enabled in the computer settings. For more details, refer to the operating instructions supplied with the computer.
- If the last-connected Bluetooth device is placed near the headset, the headset may connect automatically to the device by simply turning on the headset. If this is the case, deactivate the Bluetooth function on the last-connected device or turn off the power.
- If you cannot connect your computer to the headset, delete the headset pairing information on your computer and perform pairing again. For the operating procedures on your computer, refer to the operating instructions supplied with the computer.

Related Topic

- [How to make a wireless connection to Bluetooth devices](#)
- [Pairing and connecting with a computer \(Windows 10\)](#)
- [Listening to music from a device via a Bluetooth connection](#)
- [Disconnecting Bluetooth connection \(after use\)](#)

Connecting to a paired computer (Mac)

Compatible OS

macOS (version 11 or later)

Before starting the operation, make sure of the following:

- Depending on the computer you are using, the built-in Bluetooth adaptor may need to be turned on. If you do not know how to turn on the Bluetooth adaptor or are unsure if your computer has a built-in Bluetooth adaptor, refer to the operating instructions supplied with the computer.
- Set the computer speaker to the ON mode.
If the computer speaker is set to the  "OFF" mode, no sound can be heard from the headset.

Computer speaker in the ON mode



1 Wake the computer up if the computer is in standby (sleep) or hibernation mode.

2 Turn on the headset.

Press and hold the  (power) button (A) for about 2 seconds or more.

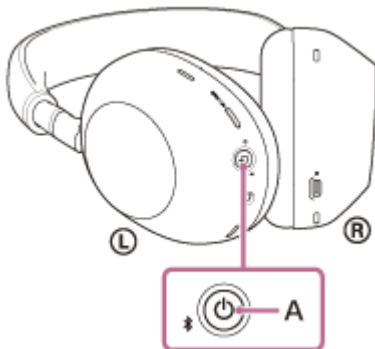

You will hear a notification sound indicating that the headset is turned on.

The indicator (blue) continues to flash even after you release your finger from the button.

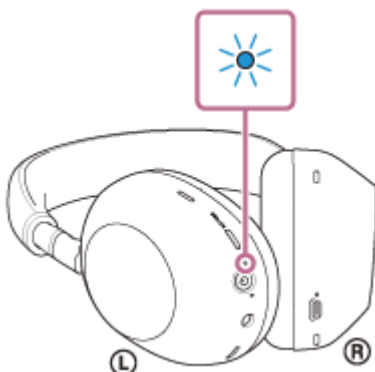

If the headset has automatically connected to the last connected device, you will hear a notification sound indicating that the connection is established.

Check the connection status on the computer. If it is not connected, proceed to step 3.

- 3 Select [ (System Preferences)] - [Bluetooth] from the Dock at the bottom of your computer screen.



- 4 Click [WH-1000XM6] on the [Bluetooth] screen while pressing the computer Control button and select [Connect] from the pop-up menu.



The connection is established. You will hear a notification sound indicating that the connection is established.

Hint

- The operation above is an example. For more details, refer to the operating instructions supplied with the computer.

Note

- If the music playback sound quality is poor, check that the A2DP function which supports music playback connections is enabled in the computer settings. For more details, refer to the operating instructions supplied with the computer.
- If the last-connected Bluetooth device is placed near the headset, the headset may connect automatically to the device by simply turning on the headset. If this is the case, deactivate the Bluetooth function on the last-connected device or turn off the power.
- If you cannot connect your computer to the headset, delete the headset pairing information on your computer and perform pairing again. For the operating procedures on your computer, refer to the operating instructions supplied with the computer.

- How to make a wireless connection to Bluetooth devices
- Pairing and connecting with a computer (Mac)
- Listening to music from a device via a Bluetooth connection
- Disconnecting Bluetooth connection (after use)

5-063-141-11(5) Copyright 2025 Sony Corporation

Wireless Noise Canceling Stereo Headset
WH-1000XM6

Pairing and connecting with a Bluetooth device

The operation to register the device that you wish to connect to is called “pairing”. First, pair a device to use it with the headset for the first time.

Before starting the operation, make sure of the following:

- The Bluetooth device is placed within 1 m (3.2 ft) of the headset.
- The headset is charged sufficiently.
- The operating instructions for the Bluetooth device is in hand.

1 Enter pairing mode on this headset.

Turn on the headset when you pair the headset with a device for the first time after you bought it or after you initialized the headset (the headset has no pairing information). The headset enters pairing mode automatically. In this case, proceed to step 2.

When you pair a second or subsequent Bluetooth device (the headset already has pairing information for other devices), press and hold the  (Bluetooth) button (A) for about 5 seconds or more to enter pairing mode manually.

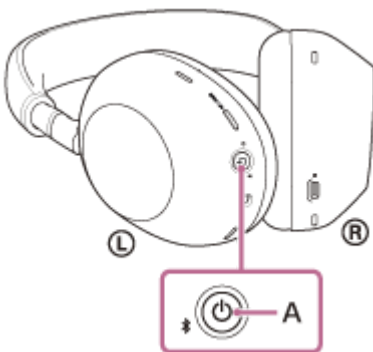

The indicator (blue) repeatedly flashes twice in a row. You will hear the voice guidance say, “Pairing”.

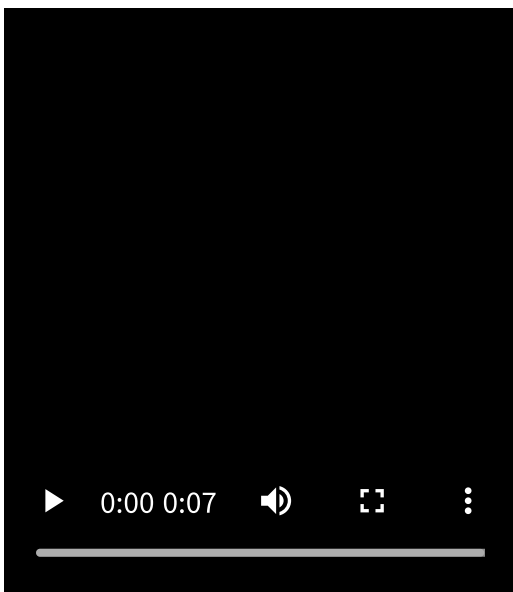

2 Perform the pairing procedure on the Bluetooth device to search for this headset.

[WH-1000XM6] will be displayed on the list of detected devices on the screen of the Bluetooth device. If it is not displayed, repeat from step 1.

3 Select [WH-1000XM6] displayed on the screen of the Bluetooth device for pairing.

If Passkey* input is required, input "0000".

* A Passkey may be called "Passcode", "PIN code", "PIN number", or "Password".

4 Make the Bluetooth connection from the Bluetooth device.

Some devices automatically connect with the headset when pairing is complete.

You will hear a notification sound indicating that the connection is established.

If they are not connected, see ["Connecting to a paired Bluetooth device"](#).

Hint

- The operation above is an example. For more details, refer to the operating instructions supplied with the Bluetooth device.
- To delete all Bluetooth pairing information, see ["Initializing the headset to restore factory settings"](#).

Note

- If pairing is not established within 5 minutes, pairing mode is canceled. In this case, turn off the power and start the operation again from step 1.
- Once Bluetooth devices are paired, there is no need to pair them again, except in the following cases:
 - Pairing information has been deleted after repair, etc.
 - When a 9th device is paired
The headset can be paired with up to 8 devices. If a new device is paired after 8 devices are already paired, the registration information of the paired device with the oldest connection date is overwritten with the information for the new device.
 - When the pairing information for the headset has been deleted from the connected Bluetooth device
 - When the headset is initialized
All of the pairing information will be deleted. In this case, delete the pairing information for the headset from the connected device and then pair them again.
- The headset can be paired with multiple devices, but can only play music from 1 paired device at a time.

Related Topic

- [How to make a wireless connection to Bluetooth devices](#)
- [Connecting to a paired Bluetooth device](#)
- [Listening to music from a device via a Bluetooth connection](#)
- [Disconnecting Bluetooth connection \(after use\)](#)
- [Initializing the headset to restore factory settings](#)

Wireless Noise Canceling Stereo Headset
WH-1000XM6

Connecting to a paired Bluetooth device

1 Turn on the headset.

Press and hold the  (power) button (A) for about 2 seconds or more.

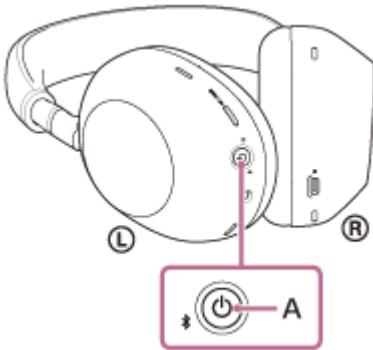

You will hear a notification sound indicating that the headset is turned on.
The indicator (blue) continues to flash even after you release your finger from the button.

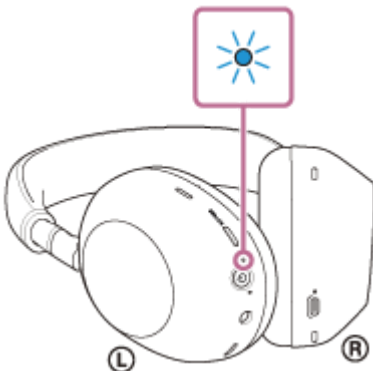

If the headset has automatically connected to the last connected device, you will hear a notification sound indicating that the connection is established.

Check the connection status on the Bluetooth device. If it is not connected, proceed to step 2.

2 Make the Bluetooth connection from the Bluetooth device.

As for the operations on your Bluetooth device, refer to the operating instructions supplied with the Bluetooth device.
When connected, you will hear a notification sound indicating that the connection is established.

Hint

- The operation above is an example. For more details, refer to the operating instructions supplied with the Bluetooth device.

Note

- When connecting, [WH-1000XM6], [LE_WH-1000XM6], or both may be displayed on the connecting device. When both or [WH-1000XM6] is displayed, select [WH-1000XM6]; when [LE_WH-1000XM6] is displayed, select [LE_WH-1000XM6].
- If the last-connected Bluetooth device is placed near the headset, the headset may connect automatically to the device by simply turning on the headset. If this is the case, deactivate the Bluetooth function on the last-connected device or turn off the power.

- If you cannot connect your Bluetooth device to the headset, delete the headset pairing information on your Bluetooth device and perform pairing again. As for the operations on your Bluetooth device, refer to the operating instructions supplied with the Bluetooth device.

Related Topic

- [How to make a wireless connection to Bluetooth devices](#)
- [Pairing and connecting with a Bluetooth device](#)
- [Listening to music from a device via a Bluetooth connection](#)
- [Disconnecting Bluetooth connection \(after use\)](#)

Wireless Noise Canceling Stereo Headset
WH-1000XM6

Connecting the headset to 2 devices simultaneously (multipoint connection)

When [Connect to 2 devices simultaneously] is turned on with the “Sony | Sound Connect” app, the headset can connect to 2 devices via Bluetooth connections simultaneously, allowing you to do the following.

- Waiting for an incoming call for 2 smartphones
You can listen to music played on one smartphone with the headset, wait for an incoming call for both smartphones, and talk if an incoming call arrives.

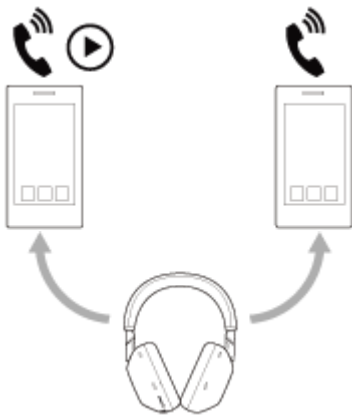

- Switching music playback between 2 devices
You can switch the music playback from one device to the other without performing a Bluetooth reconnection.



Connecting the headset to 2 devices via Bluetooth connections simultaneously

Before connecting, make sure that the “Sony | Sound Connect” app is installed on one of the 2 devices.

- 1 Pair the headset with 2 devices, respectively.
- 2 Operate the device on which the “Sony | Sound Connect” app is installed to establish a Bluetooth connection with the headset.
- 3 Turn on [Connect to 2 devices simultaneously] with the “Sony | Sound Connect” app.
- 4 Operate the second device to establish a Bluetooth connection with the headset.

When Bluetooth connections are established between 2 devices and the headset, another paired device can be connected via Bluetooth connection.

If you try to make a Bluetooth connection with the headset by operating the third device, the Bluetooth connection with the last device that played music will be maintained, and the Bluetooth connection with the other device will be disconnected. Then a Bluetooth connection between the third device and the headset is established.

Music playback when the headset is connected to 2 devices via Bluetooth connections

- When playing music by operating the headset, the music is played from the device that played last.
- If you start playback by operating the second device while playing music on the first device, the music from the second device will be heard via the headset.

Talking on the phone when the headset is connected to 2 devices via Bluetooth connections

- When the headset is connected to 2 smartphones, etc. via Bluetooth connections simultaneously, both devices will be in standby mode.
- When an incoming call arrives to the first device, a ring tone is heard via the headset.

When an incoming call arrives to the second device while talking on the headset, a ring tone is heard overlapping the call on the first device. In this case, you can use the headset to answer or reject the second call, but you cannot end the first call.

If you want to end the first call, you will need to operate the connected device.

If the second call is received without finishing the first call, the first call will continue silently. When the second call is finished, the call will return to the first call.

Note

- If the connected device switches at an unintended time, you may be able to prevent the device from switching by turning off the notification and operation sound on your smartphone or lowering the volume.

Related Topic

- [What you can do with the “Sony | Sound Connect” app](#)
- [How to make a wireless connection to Bluetooth devices](#)
- [Supported codecs](#)

Wireless Noise Canceling Stereo Headset
WH-1000XM6

Switching audio between multiple devices with “audio switch”

The “audio switch” function is a Google feature that switches audio between Android devices. Headsets that support “audio switch” can connect to multiple devices. When you use your headset on devices with “audio switch” turned on, the audio heard from your headset seamlessly switches between devices. Your device notifies you when the audio has switched devices.

Compatible smartphones

Android 8 or later

For details on “audio switch”, refer to the following URL.

https://support.google.com/android/?p=switch_audio

To use this function, you need to connect your headset and device via Google Fast Pair.

For details on Google Fast Pair, refer to the following URL.

<https://support.google.com/android/answer/9417604>

Note

- The specifications of “audio switch” are subject to change without notice.

Wireless Noise Canceling Stereo Headset
WH-1000XM6

Sharing music with “Auracast™ broadcast audio”

“Auracast™ broadcast audio” is a feature of LE Audio.

Headsets that support “Auracast™ broadcast audio” allow you to enjoy the same music simultaneously on multiple headsets from a single smartphone.

Note

- A connected device that supports “Auracast™ broadcast audio” is required.
For details, refer to the operating instructions supplied with the connected device.

Wireless Noise Canceling Stereo Headset
WH-1000XM6

Disconnecting Bluetooth connection (after use)

1 Disconnect the Bluetooth connection by operating the Bluetooth device.

You will hear a notification sound.

2 Turn off the headset.

You will hear a notification sound.

Hint

- When you finish playing music, the Bluetooth connection may terminate automatically depending on the Bluetooth device.

Related Topic

- [Turning off the headset](#)

Wireless Noise Canceling Stereo Headset
WH-1000XM6

Using the supplied headphone cable

If you use the headset at a place where it is restricted to use Bluetooth devices such as on an airplane, you can use the headset as noise canceling headphones while the headset is connected to a device via the supplied headphone cable and the headset is turned on.

The headset supports High-Resolution Audio playback.

1 Connect a playback device to the headphone cable input jack with the supplied headphone cable.

Be sure to connect the L-shaped plug into the connecting device.

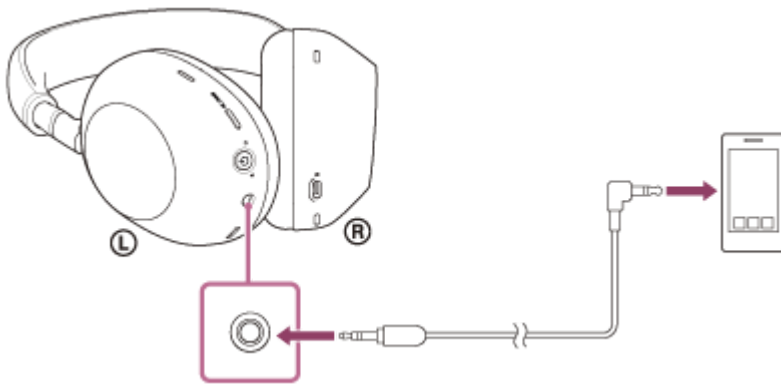

Hint

- If you disconnect the headphone cable from the headset while the headset is turned on, you can enjoy music and calls wirelessly using the Bluetooth function.
- You can listen to music even if the headset is turned off. In this case, the noise canceling function cannot be used.
- To enjoy High-Resolution Audio music or use functions such as noise canceling/Ambient Sound Mode, turn the headset on.
- When an incoming call arrives, a ring tone is heard via the headset. Answer the call using your smartphone, and talk using the microphone of the phone. You can hear the caller's voice from the headset. If you disconnect the headphone cable from the smartphone, you can talk using the microphone and speaker of the phone.

Note

- Use the supplied headphone cable only.
- Make sure that you insert the cable until it clicks. If the plug is not connected correctly, you may not hear the sound properly.
- When using the headphone cable, the Bluetooth function cannot be used.
- You can use Quick Attention Mode and Speak-to-Chat while the headset is connected to a device via the supplied headphone cable and the headset is turned on. Perform operations, such as adjusting the volume and play/pause, on the playback device. When the headset is turned off, you cannot use Quick Attention Mode and Speak-to-Chat.
- The NC/AMB (noise canceling/Ambient Sound Mode) button cannot be used when the headset is turned off.
- When talking on the phone by connecting the headphone cable with the headset, disable Speak-to-Chat. If Speak-to-Chat is enabled, the caller's voice will not be heard from the headset.

Related Topic

- [Using the noise canceling function](#)
- [Listening to ambient sound during music playback \(Ambient Sound Mode\)](#)
- [Listening to ambient sound quickly \(Quick Attention Mode\)](#)
- [Speaking with someone while wearing the headset \(Speak-to-Chat\)](#)

5-063-141-11(5) Copyright 2025 Sony Corporation

Wireless Noise Canceling Stereo Headset
WH-1000XM6

Listening to music from a device via a Bluetooth connection

If your Bluetooth device supports the following profiles, you can enjoy listening to music and control the device from your headset via a Bluetooth connection.

- A2DP (Advanced Audio Distribution Profile)
You can enjoy high-quality music wirelessly.
- AVRCP (Audio Video Remote Control Profile)
You can adjust the volume, etc.

The operation may vary depending on the Bluetooth device. Refer to the operating instructions supplied with the Bluetooth device.

1 Connect the headset to a Bluetooth device.

2 Put the headset on your ears.

See "[Wearing the headset](#)" for how to wear the headset on your ears.

3 Operate the Bluetooth device to start playback and adjust the volume to a moderate level.

4 Adjust the volume using the touch sensor control panel of the headset.

- Increase the volume: Swipe up repeatedly until the volume reaches the desired level.

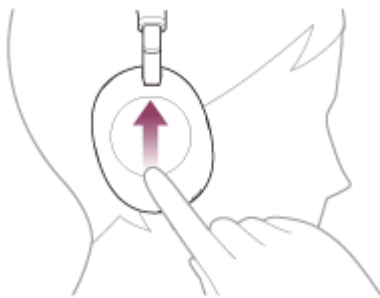

- Lower the volume: Swipe down repeatedly until the volume reaches the desired level.



- Change the volume continuously: Swipe up or down and hold. Release at the desired volume level.

When the volume reaches the maximum or minimum, an alarm sounds.

Hint

- The headset supports SCMS-T content protection. You can enjoy music and other audio on the headset from a device such as a portable TV that supports SCMS-T content protection.
- Depending on the Bluetooth device, it may be necessary to adjust the volume or set the audio output setting on the device.
- The headset volume during a call and during music playback can be independently adjusted. Even if you change the volume during music playback, the volume of a call does not change.

Note

- If the communication condition is poor, the Bluetooth device may react incorrectly to the operation on the headset.

Related Topic

- [How to make a wireless connection to Bluetooth devices](#)
- [Controlling the audio device \(Bluetooth connection\)](#)
- [Using the noise canceling function](#)

Wireless Noise Canceling Stereo Headset
WH-1000XM6

Controlling the audio device (Bluetooth connection)

If your Bluetooth device supports the device operating function (compatible profile: AVRCP), the following operations are available. The available functions may vary depending on the Bluetooth device, so refer to the operating instructions supplied with the device.

You can use the touch sensor control panel to perform the following operations.

- Play/Pause: Tap the touch sensor control panel twice quickly (with an interval of about 0.4 seconds).

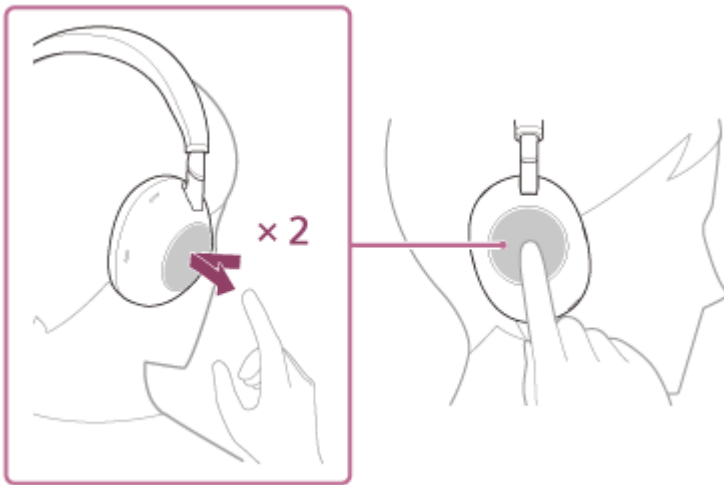

- Skip to the beginning of the next track: Swipe forward and release.

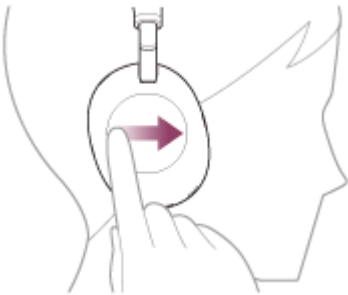

- Skip to the beginning of the previous track (or the current track during playback): Swipe backward and release.

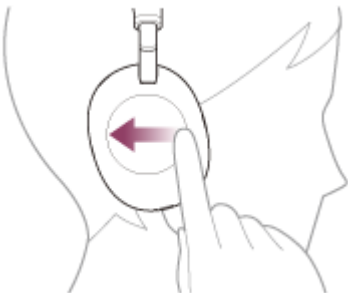

- Fast-forward: Swipe forward and hold. (It takes a while until fast-forwarding starts.) Release at the desired playback point.

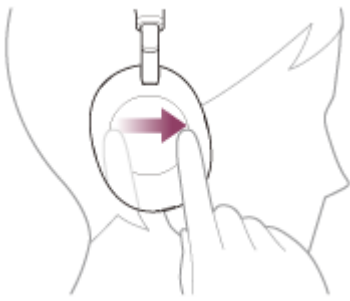

- Fast-reverse: Swipe backward and hold. (It takes a while until fast-reversing starts.) Release at the desired playback point.



- Increase the volume: Swipe up repeatedly until the volume reaches the desired level.

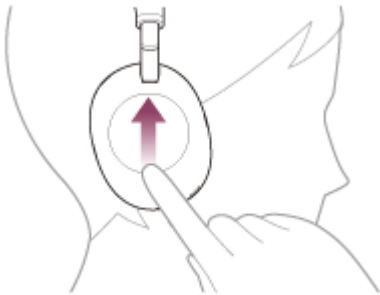

- Lower the volume: Swipe down repeatedly until the volume reaches the desired level.



- Change the volume continuously: Swipe up or down and hold. Release at the desired volume level.

Note

- If the communication condition is poor, the Bluetooth device may react incorrectly to the operation on the headset.
- The available functions may vary depending on the connected device, the music software, or app used. In some cases, it may operate differently or may not work even when the operations described above are performed.

Wireless Noise Canceling Stereo Headset
WH-1000XM6

About 360 Reality Audio

What is 360 Reality Audio?

360 Reality Audio is a new music experience using Sony's 360 three-dimensional audio technology.

Positional information is attached to each sound source such as vocals, chorus, and musical instruments, and are placed in a spherical space.

Listeners can experience a three-dimensional sound field as if they are immersed in a live performance of the artists.

Conditions of use

Download and use a (paid) music streaming service app that supports 360 Reality Audio on an iOS or Android device such as a smartphone.

By optimizing the sound field and the acoustic feature of headset with the "Sony | Sound Connect" app, you can enjoy a more realistic sense of reality.

For details on 360 Reality Audio, refer to the following URL.

<https://www.sony.net/360RA/>

Note

- Service is not available in certain countries and regions.

Wireless Noise Canceling Stereo Headset
WH-1000XM6

Enjoying seamless playback with speakers (Auto Switch)

You can enjoy wireless playback while having the audio output source automatically switched between the Auto Switch compatible headset and the speaker without operating the headset or the speaker.

For details on the Auto Switch compatible devices, refer to the following URL.

https://www.sony.net/asw_comp_hp

Before using Auto Switch, make sure of the following:

- Install the “Sony | Sound Connect” app on your smartphone.
- Update the software of the speaker and headset to the latest version.

1 Pair the Auto Switch compatible speaker with your smartphone that has the “Sony | Sound Connect” app installed.

If already paired, connect the speaker to your smartphone.

2 Check that the Bluetooth standby function of the speaker is enabled in the “Sony | Sound Connect” app.

3 Turn off the speaker.

4 Connect the headset to your smartphone and follow the on-screen instructions from Auto Switch to enable the linkage with the speaker.

5 Start playing music on your smartphone.

Start playing music on the smartphone on which the “Sony | Sound Connect” app is installed and the Auto Switch settings are specified.

When you turn off the headset while music playback from the headset is in progress, the audio output source for music playback is automatically switched to the speaker.

If the audio output source is not switched as expected, try bringing the speaker and the headset closer to each other.

When you turn on and put on the headset while music playback from the speaker is in progress, the audio output source for music playback is automatically switched to the headset.

To adjust the volume

Adjust the volume on the headset or speaker during playback. Changing the volume affects only the headset or speaker currently playing music.

To disable Auto Switch

Cancel the link for Auto Switch on the “Sony | Sound Connect” app. Initializing the headset or the linked speaker cancels the link as well.

Hint

- If you do not want to automatically switch the audio output source while the speaker linkage is enabled, pause music playback on the smartphone beforehand.

Note

- Auto Switch does not work for the hands-free function of the connected smartphone.

Wireless Noise Canceling Stereo Headset
WH-1000XM6

What is noise canceling?

The noise canceling function generates antiphase sound against outside surrounding noises (such as noises in vehicles or noises from air conditioners indoors) to reduce the surrounding noises by canceling them out.

Note

- Because the noise canceling performance is automatically optimized according to changes in the wearing condition and usage environment, you may notice fluctuations in the noise canceling effect.
- Depending on the type of noise or if it is used in a very quiet environment, you may not feel the noise canceling effects, or you may feel that some noise is increased. In this case, putting the headset back on your ears may fix the problem.
- When you are wearing the headset, depending on how you wear the headset, the noise canceling effects may be decreased or may not work, or a beeping sound (feedback) may be heard. In this case, take off the headset and put it on again.
- The noise canceling function works primarily on noise in the low frequency band such as vehicles and air conditioning. While noise is reduced, it is not completely canceled.
- When you use the headset in a car or a bus, noise may occur depending on street conditions.
- Smartphones may cause interference and noise. Should this occur, move the headset further away from the smartphone.
- Do not cover the microphones (A) on the left and right units of the headset with your hand, etc. The effect of the noise canceling function or Ambient Sound Mode may not work properly or a beeping sound (feedback) may occur. If any of this is the case, remove your hands, etc. from the left and right microphones.

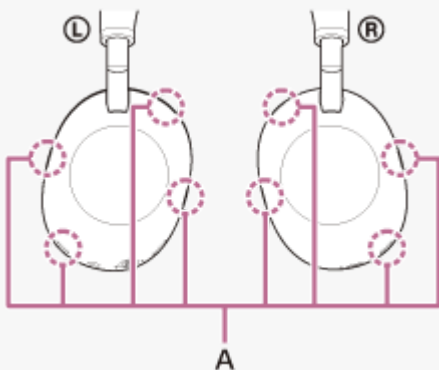

For details on how to use the noise canceling function, refer to the following Related Topic.

Related Topic

- [Using the noise canceling function](#)

Using the noise canceling function

If you use the noise canceling function, you can enjoy music without being disturbed by ambient noise.

1 Turn on the headset.

You will hear a notification sound indicating that the headset is turned on.

When you are using the headset for the first time after purchase or just after initializing the headset, the noise canceling function is turned on automatically when you turn on the headset. Any changes made to the settings are retained from this point on.

2 Press the NC/AMB (noise canceling/Ambient Sound Mode) button (A) to change the settings of the noise canceling function.

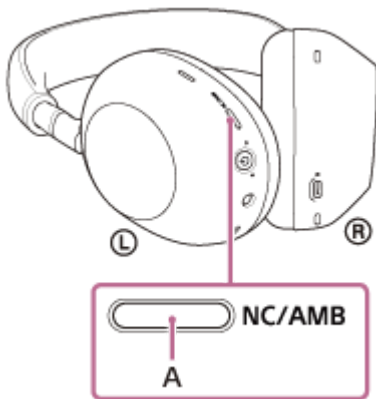

Each time the button is pressed, the function switches as follows.

Ambient Sound Mode: ON

You will hear a notification sound.



Noise canceling function: ON

You will hear a notification sound.

Checking the notification sound

- When Ambient Sound Mode is turned on

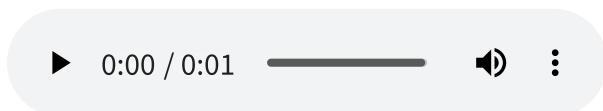

- When the noise canceling function is turned on

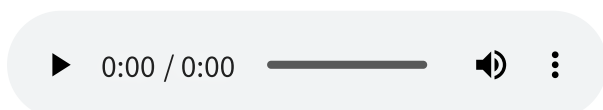

Watch the video for how to use the noise canceling function.

No audio explanation is available.

For models of countries and regions excluding Chinese mainland:

https://rd1.sony.net/help/mdr/mov0088/h_zz/

For models of Chinese mainland:

<https://rd1.sony.net/help/mdr/mov0088/zh-cn/>

Hint

- If you connect the supplied headphone cable while using the noise canceling function with a Bluetooth connection, the Bluetooth function is turned off, but you can continue to use the noise canceling function.
- When you use the headset as ordinary headphones, turn off the headset and use the supplied headphone cable.
- You can also change the settings of the noise canceling function and Ambient Sound Mode with the “Sony | Sound Connect” app.
- You can select one of the following on the “Sony | Sound Connect” app to set how you want the functions to change when you press the NC/AMB (noise canceling/Ambient Sound Mode) button.
 - Noise canceling function: ON ➡ Ambient Sound Mode: ON ➡ Noise canceling function: OFF/Ambient Sound Mode: OFF
 - Noise canceling function: ON ➡ Ambient Sound Mode: ON
 - Ambient Sound Mode: ON ➡ Noise canceling function: OFF/Ambient Sound Mode: OFF
 - Noise canceling function: ON ➡ Noise canceling function: OFF/Ambient Sound Mode: OFF

Related Topic

- [About the voice guidance](#)
- [Turning on the headset](#)
- [What is noise canceling?](#)
- [Listening to ambient sound during music playback \(Ambient Sound Mode\)](#)
- [What you can do with the “Sony | Sound Connect” app](#)

Wireless Noise Canceling Stereo Headset
WH-1000XM6

Always automatically optimizing the noise canceling performance to suit the wearer and usage environment

Auto NC Optimizer automatically measures the headset's wearing condition and usage environment to constantly optimize noise canceling characteristics. Automatically provides the ideal noise canceling effect for the wearing condition and usage environment.

Note

- Because the noise canceling performance is automatically optimized according to changes in the wearing condition and usage environment, you may notice fluctuations in the noise canceling effect.

Wireless Noise Canceling Stereo Headset
WH-1000XM6

Listening to ambient sound during music playback (Ambient Sound Mode)

The microphones built into the left and right headset units make it easier to hear ambient sound. You can hear ambient sound while enjoying music.

1 Turn on the headset.

You will hear a notification sound indicating that the headset is turned on.

When you are using the headset for the first time after purchase or just after initializing the headset, the noise canceling function is turned on automatically when you turn on the headset. Any changes made to the settings are retained from this point on.

2 Press the NC/AMB (noise canceling/Ambient Sound Mode) button (A) to switch to the Ambient Sound Mode.

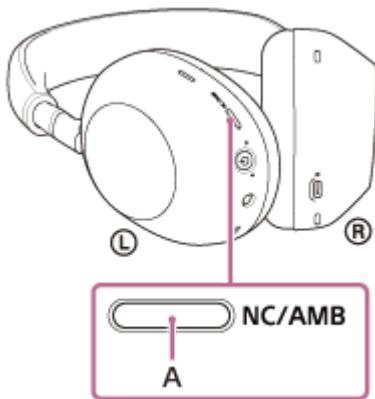

Each time the button is pressed, the function switches as follows.

Noise canceling function: ON

You will hear a notification sound.



Ambient Sound Mode: ON

You will hear a notification sound.

Checking the notification sound

- When the noise canceling function is turned on

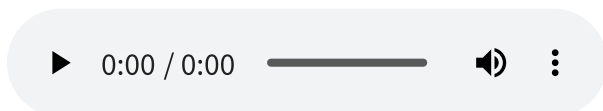

- When Ambient Sound Mode is turned on

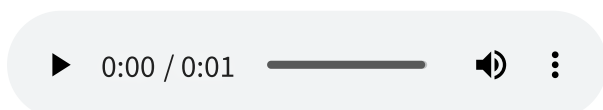

Watch the video for how to use Ambient Sound Mode.

No audio explanation is available.

For models of countries and regions excluding Chinese mainland:

https://rd1.sony.net/help/mdr/mov0088/h_zz/

For models of Chinese mainland:

<https://rd1.sony.net/help/mdr/mov0088/zh-cn/>

Hint

- Ambient Sound Mode settings changed with the “Sony | Sound Connect” app are stored in the headset. Once you change the settings, you can enjoy music with the stored settings just by turning on the Ambient Sound Mode even when the headset is connected to other devices which do not have the “Sony | Sound Connect” app installed.
- You can select one of the following on the “Sony | Sound Connect” app to set how you want the functions to change when you press the NC/AMB (noise canceling/Ambient Sound Mode) button.
 - Noise canceling function: ON ➡ Ambient Sound Mode: ON ➡ Noise canceling function: OFF/Ambient Sound Mode: OFF
 - Noise canceling function: ON ➡ Ambient Sound Mode: ON
 - Ambient Sound Mode: ON ➡ Noise canceling function: OFF/Ambient Sound Mode: OFF
 - Noise canceling function: ON ➡ Noise canceling function: OFF/Ambient Sound Mode: OFF

Note

- Depending on the ambient conditions and the type/volume of audio playback, ambient sounds may not be heard even when using Ambient Sound Mode. Do not use the headset in places where it would be dangerous if you are unable to hear ambient sounds, such as on a road with car and bicycle traffic.
- If the headset is not being worn properly on your ears, the Ambient Sound Mode may not work correctly. Wear the headset properly.
- Depending on the surrounding environment, wind noise may increase when the Ambient Sound Mode is turned on. In that case, lower the volume of Ambient Sound Mode using the “Sony | Sound Connect” app. If the wind noise is still significant, turn off Ambient Sound Mode.
- When Ambient Sound Mode is on, if your fingers or hair touch the noise canceling function microphones (external), you may hear a loud sound.

Related Topic

- [About the voice guidance](#)
- [Using the noise canceling function](#)
- [What you can do with the “Sony | Sound Connect” app](#)

Wireless Noise Canceling Stereo Headset
WH-1000XM6

Automatically adjusting the level of ambient sound capture according to the ambient noise level (Auto Ambient Sound)

Auto Ambient Sound automatically adjusts the level of ambient sound capture according to the ambient noise level when the Auto Ambient Sound setting is on.

While still capturing ambient sound, the system automatically adjusts the amount of ambient sound captured in noisy environments, allowing you to enjoy music comfortably.

Hint

- You can turn Auto Ambient Sound on/off and change the sensitivity settings with the “Sony | Sound Connect ” app.

Wireless Noise Canceling Stereo Headset
WH-1000XM6

Listening to ambient sound quickly (Quick Attention Mode)

This function turns down music, call sounds, and the ringtone to allow ambient sound to be easily heard. The Quick Attention Mode is useful for quickly listening to train announcements, etc.

To activate the Quick Attention Mode

Touch the entire touch sensor control panel (A) of the headset. The Quick Attention Mode is activated only when you are touching the touch sensor control panel.

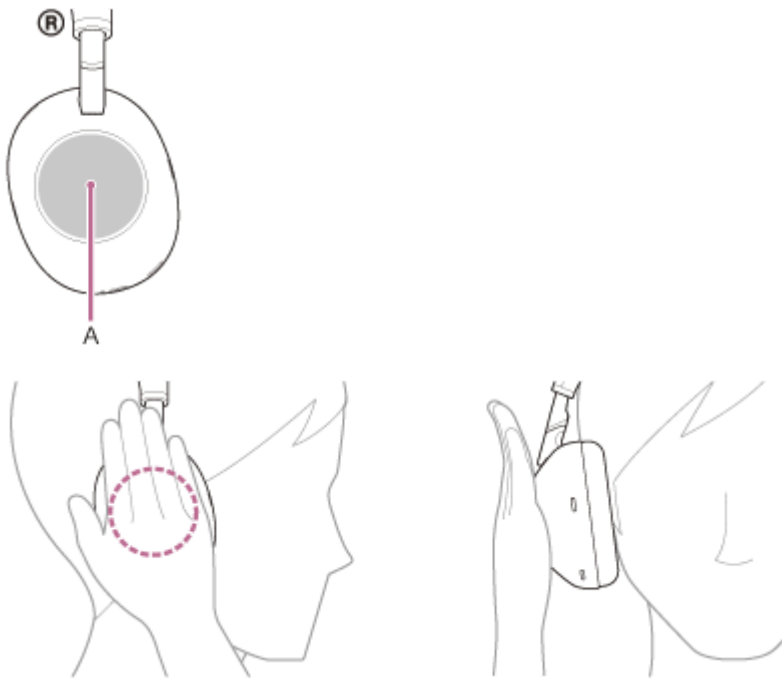

To deactivate the Quick Attention Mode

Release your hand from the touch sensor control panel.

About the instruction manual video

Watch the video for how to use the Quick Attention Mode.

No audio explanation is available.

For models of countries and regions excluding Chinese mainland:

https://rd1.sony.net/help/mdr/mov0089/h_zz/

For models of Chinese mainland:

<https://rd1.sony.net/help/mdr/mov0089/zh-cn/>

Note

- If you touch as follows, the function may not work properly.
 - The whole touch sensor control panel is not covered.



– The touch sensor control panel is not touched.



- Depending on the ambient conditions and the type/volume of audio playback, ambient sounds may not be heard even when using the Quick Attention Mode. Do not use the headset in places where it would be dangerous if you are unable to hear ambient sounds, such as on a road with car and bicycle traffic.
- If the headset is not being worn properly, the Quick Attention Mode may not work correctly. Wear the headset properly.

Wireless Noise Canceling Stereo Headset
WH-1000XM6

Speaking with someone while wearing the headset (Speak-to-Chat)

If Speak-to-Chat is enabled in advance, the Speak-to-Chat mode starts automatically when you talk to someone. The headset lowers the volume of the music being played and captures the voice of the person you are conversing with on the microphones to make it easier to hear.

When the headset does not detect the wearer's voice for a certain period of time, the Speak-to-Chat mode ends automatically.

If you want to end the mode before that, use the headset buttons or touch sensor control panel.

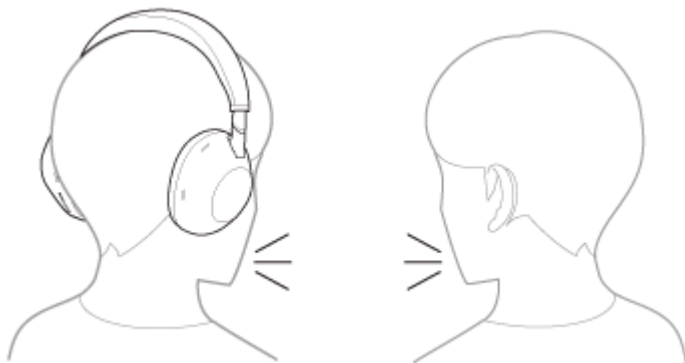

To enable Speak-to-Chat

To activate the Speak-to-Chat mode, Speak-to-Chat must be enabled in advance.

In the factory settings, Speak-to-Chat is disabled. To enable, change the setting with the “Sony | Sound Connect” app.

To disable Speak-to-Chat

To disable, change the setting with the “Sony | Sound Connect” app.

Hint

- You can also use the “Sony | Sound Connect” app to switch between enabled/disabled, change the sensitivity of the automatic audio detection, and change the time until the Speak-to-Chat mode ends. In the factory settings, the time until the mode ends is set to about 15 seconds.

Note

- The Speak-to-Chat mode activates when the headset detects the speech of the person wearing the headset, but in rare cases it may activate in response to vibrations caused by devices such as electric toothbrushes, electric massagers, and electric shavers, as well as activities such as brushing your teeth, coughing, or humming, or to sounds such as other people's voices, ambient environmental sounds, or transportation announcements. In cases where Speak-to-Chat frequently activates by accident, set the Speak-to-Chat mode to “L Sensitivity”.
- Due to ambient noise, the speech of the person wearing the headset may not be detected, and the Speak-to-Chat mode may not activate. In this case, try speaking longer or louder. In some cases, the Speak-to-Chat mode may not activate even when speaking longer and with a louder voice in extremely noisy environments such as in an airplane.

Related Topic

- [What you can do with the “Sony | Sound Connect” app](#)

Wireless Noise Canceling Stereo Headset
WH-1000XM6

About the sound quality mode

The following 3 modes during Bluetooth playback can be selected. You can switch the settings and check the sound quality mode with the “Sony | Sound Connect” app.

Prioritize Sound Quality: Prioritizes the sound quality (default).

Prioritize Stable Connection: Prioritizes the stable connection.

Low latency: Connect with low latency.

- When you want to prioritize the sound quality, select [Prioritize Sound Quality].
- If the connection is unstable, such as when producing only intermittent sound, select [Prioritize Stable Connection].
- If you want a low-latency connection, select [Low latency].

Note

- [Low latency] is not displayed in the following cases.
 - When using a connected device that does not support LE Audio or Xperia 1 IV/5 IV
 - When the “Sony | Sound Connect” app and headset software are not up-to-date
- The playback time may shorten depending on the sound quality and the conditions under which you are using the headset.
- Depending on the ambient conditions in the area where you are using the headset, intermittent sound may still occur even if [Prioritize Stable Connection] is selected.
- The maximum playback time may be shorter in the [Prioritize Sound Quality] mode and the [Low latency] mode.
- [Low latency] mode focuses on low latency, resulting in a lower connection stability compared to [Prioritize Sound Quality] mode and [Prioritize Stable Connection] mode. If you experience sound stuttering due to poor reception, switch to [Prioritize Sound Quality] mode or [Prioritize Stable Connection] mode.
- [Low latency] mode is an LE Audio connection. To connect using LE Audio, refer to [“Pairing and connecting with an Android smartphone using LE Audio”](#) for details.

Related Topic

- [What you can do with the “Sony | Sound Connect” app](#)

Wireless Noise Canceling Stereo Headset
WH-1000XM6

Supported codecs

A codec is an “audio coding algorithm” used when transmitting sound wirelessly via a Bluetooth connection.

The headset supports the following codecs.

When connected using Classic Audio via an A2DP connection (for music playback): SBC, AAC, LDAC

When connected using LE Audio: LC3

- SBC

This is an abbreviation for Subband Codec.

SBC is the standard audio coding technology used in Bluetooth devices.

All Bluetooth devices support SBC.

- AAC

This is an abbreviation for Advanced Audio Coding.

AAC is mainly used in Apple products such as iPhone that can provide a higher sound quality than that of SBC.

- LDAC

LDAC is an audio coding technology developed by Sony that enables the transmission of High-Resolution (Hi-Res) Audio content, even over a Bluetooth connection.

Unlike other Bluetooth-compatible coding technologies such as SBC, it operates without any down-conversion of the High-Resolution Audio content*.

It allows approximately 3 times more data** than those other technologies to be transmitted over a Bluetooth wireless network with unprecedented sound quality, employing efficient coding and optimized packetization.

- LC3

This is an abbreviation for Low Complexity Communication Codec.

LC3 is a codec for LE Audio and achieves low latency transmission.

* excluding DSD format contents.

** in comparison with SBC when the bitrate of 990 kbps (96/48 kHz) or 909 kbps (88.2/44.1 kHz) is selected.

When music in one of the above codecs is transmitted from a connected device, the headset switches to that codec automatically and plays back the music in the same codec.

If the connected device supports a codec of higher sound quality than SBC, you may need to set the device beforehand to enjoy music with the desired codec from the supported codecs.

Refer to the operating instructions supplied with the device regarding setting the codec.

When connected to LE Audio or playing music, the music playback is performed in LC3 codec.

For LE Audio connections, use the “Sony | Sound Connect” app and set the sound quality mode to [Low latency]. In [Prioritize Sound Quality] (factory settings), LE Audio connection is not available.

Refer to the operating instructions supplied with the device you are connecting to, as some settings may be necessary in advance.

When connected to LE Audio, if you launch a gaming app that supports GMAP, the profile will automatically switch.

GMAP is one of the LE Audio profiles that provides ultra-low latency that is ideal for gaming.

To connect using GMAP, the smartphone needs to be compatible with GMAP. For details about compatibility, refer to the operating instructions supplied with your smartphone.

Related Topic

- [About the sound quality mode](#)

Wireless Noise Canceling Stereo Headset
WH-1000XM6

About the DSEE Extreme function

DSEE Extreme uses AI technology to reproduce the frequency responses of the original sound source lost during compression with high accuracy.

You can switch the settings with the “Sony | Sound Connect” app.

Depending on the specifications of the playback device, the DSEE Extreme function may be disabled when transmitting a compressed sound source using LDAC.

Note

- When DSEE Extreme is set to [Auto], the available operating time is reduced.
- DSEE Extreme is disabled during a call.

Related Topic

- [What you can do with the “Sony | Sound Connect” app](#)

Wireless Noise Canceling Stereo Headset
WH-1000XM6

Using 360 Upmix for Cinema

Using 360 Reality Audio Upmix for Cinema makes playback of all stereo sound sources, including streaming services, sound like spatial audio.

You can switch the settings with the “Sony | Sound Connect” app.

Note

- In the following cases, the set 360 Upmix for Cinema will be disabled.
 - During a call
 - When using the headset while connected via the headphone cable
- The 360 Upmix for Cinema setting is retained even after the headset is turned off. When the headset is turned on, it returns to the previous setting.

Wireless Noise Canceling Stereo Headset
WH-1000XM6

Receiving a call

You can enjoy a hands-free call with a smartphone that supports the Bluetooth profile HFP (Hands-free Profile) or HSP (Headset Profile), via a Bluetooth connection.

- If your smartphone supports both HFP and HSP, set it to HFP.
- The operation may vary depending on the smartphone. Refer to the operating instructions supplied with the smartphone.
- Depending on the connected device or the application you are using, the functions may not work properly even if you try to operate them with the headset.

The headset microphones are designed to easily pick up the wearer's voice when worn correctly. If the headset is not worn correctly, it may be difficult to pick up the wearer's voice. When making a call, make sure to wear the headset correctly.

Ring tone

When an incoming call arrives, a ring tone will be heard from the headset, and the indicator (blue) flashes quickly. You will hear either of following ring tones, depending on your smartphone.

- Ring tone set on the headset
- Ring tone set on the smartphone
- Ring tone only for a Bluetooth connection set on the smartphone

- 1 **Connect the headset to a smartphone via a Bluetooth connection beforehand.**
- 2 **When you hear the ring tone, tap the touch sensor control panel twice quickly (with an interval of about 0.4 seconds) to receive the call.**

When you receive an incoming call during music playback, playback pauses and a ring tone will be heard from the headset.

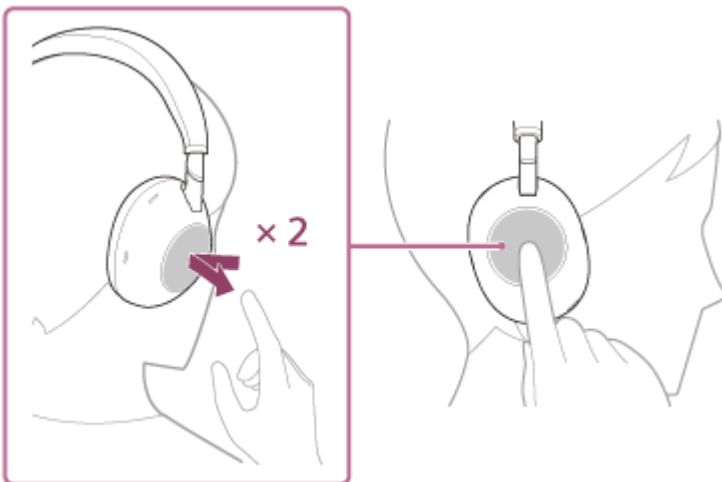

The headset has omnidirectional microphones. You can talk without worrying about the position of the microphone.

If no ring tone is heard via the headset

- The headset may not be connected with the smartphone over HFP or HSP. Check the connection status on the smartphone.

- If music playback does not pause automatically, operate the playback device to pause playback.

3 Adjust the volume using the touch sensor control panel.

- Increase the volume: Swipe up repeatedly until the volume reaches the desired level.

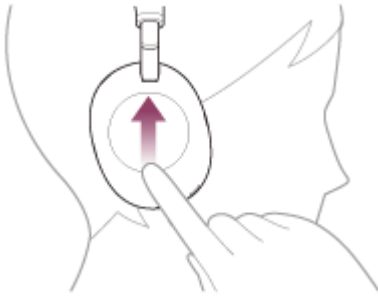

- Lower the volume: Swipe down repeatedly until the volume reaches the desired level.



- Change the volume continuously: Swipe up or down and hold. Release at the desired volume level.

When the volume reaches the maximum or minimum, an alarm sounds.

4 When you finish your phone call, tap the touch sensor control panel twice quickly (with an interval of about 0.4 seconds) to end the call.

If you received a call during music playback, music playback resumes automatically after ending the call.

Hint

- When receiving a call when using a smartphone, some smartphones may receive a call on the phone instead of the headset. Transfer the call to the headset on your smartphone.
- Volume for a call can be adjusted during a telephone conversation only.
- The headset volume during a call and during music playback can be independently adjusted. Even if you change the volume during a call, the volume of music playback does not change.

Note

- Depending on the connected device or playback application you are using, when you receive an incoming call during music playback, playback may not resume automatically even after you finish the call.
- Use a smartphone at least 50 cm (1.6 ft) away from the headset. Noise may result if the smartphone is too close to the headset.
- In order to make it easier for you to hear your own voice during a phone call, the microphones work to capture ambient sounds (Sidetone function). If your voice sounds too loud or the sounds in your surroundings are bothering you, turn off [Capture Voice During a Phone Call] on the “Sony | Sound Connect” app.

Related Topic

- [How to make a wireless connection to Bluetooth devices](#)
- [Making a call](#)
- [Functions for a phone call](#)

5-063-141-11(5) Copyright 2025 Sony Corporation

Wireless Noise Canceling Stereo Headset
WH-1000XM6

Making a call

You can enjoy a hands-free call with a smartphone that supports the Bluetooth profile HFP (Hands-free Profile) or HSP (Headset Profile), via a Bluetooth connection.

- If your smartphone supports both HFP and HSP, set it to HFP.
- The operation may vary depending on the smartphone. Refer to the operating instructions supplied with the smartphone.
- Depending on the connected device or the application you are using, the functions may not work properly even if you try to operate them with the headset.

The headset microphones are designed to easily pick up the wearer's voice when worn correctly. If the headset is not worn correctly, it may be difficult to pick up the wearer's voice. When making a call, make sure to wear the headset correctly.

1 Connect the headset to a smartphone via a Bluetooth connection.

2 Operate your smartphone to make a call.

When you make a call, the dial tone is heard from the headset.

If you make a call during music playback, playback pauses.

If no dial tone is heard via the headset, switch the call device to the headset using your smartphone.

3 Adjust the volume using the touch sensor control panel.

- Increase the volume: Swipe up repeatedly until the volume reaches the desired level.

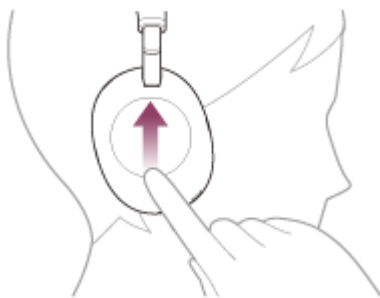

- Lower the volume: Swipe down repeatedly until the volume reaches the desired level.



- Change the volume continuously: Swipe up or down and hold. Release at the desired volume level.

When the volume reaches the maximum or minimum, an alarm sounds.

- 4 When you finish your phone call, tap the touch sensor control panel twice quickly (with an interval of about 0.4 seconds) to end the call.

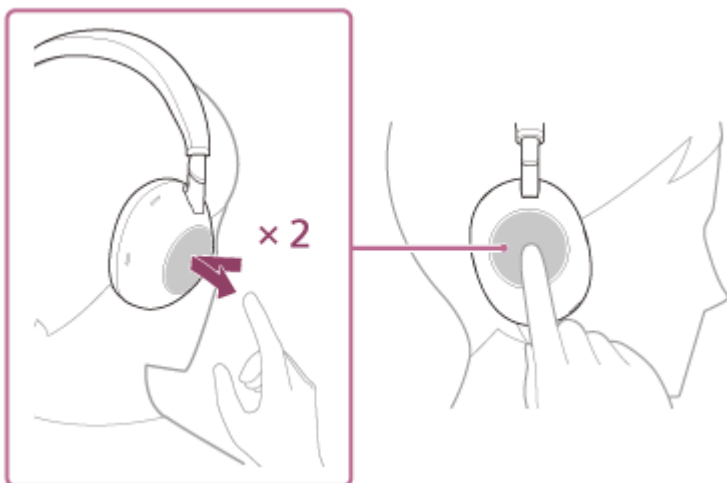

If you made a call during music playback, music playback resumes automatically after ending the call.

Hint

- Volume for a call can be adjusted during a telephone conversation only.
- The headset volume during a call and during music playback can be independently adjusted. Even if you change the volume during a call, the volume of music playback does not change.

Note

- Depending on the connected device or playback application you are using, when you make a call during music playback, playback may not resume automatically even after you finish the call.
- Use a smartphone at least 50 cm (1.6 ft) away from the headset. Noise may result if the smartphone is too close to the headset.
- In order to make it easier for you to hear your own voice during a phone call, the microphones work to capture ambient sounds (Sidetone function). If your voice sounds too loud or the sounds in your surroundings are bothering you, turn off [Capture Voice During a Phone Call] on the “Sony | Sound Connect” app.

Related Topic

- [How to make a wireless connection to Bluetooth devices](#)
- [Receiving a call](#)
- [Functions for a phone call](#)

Wireless Noise Canceling Stereo Headset
WH-1000XM6

Functions for a phone call

The functions available during a call may vary depending on the profile supported by your smartphone. In addition, even if the profile is the same, the available functions may vary depending on the smartphone.

Depending on the connected device or the application you are using, the functions may not work properly even if you try to operate them with the touch sensor control panel.

Refer to the operating instructions supplied with the smartphone.

Supported profile: HFP (Hands-free Profile)

During standby/music playback

- Hold your finger to the touch sensor control panel to start up the voice dial function of the smartphone, or activate the Google app on the Android smartphone or Siri on the iPhone.

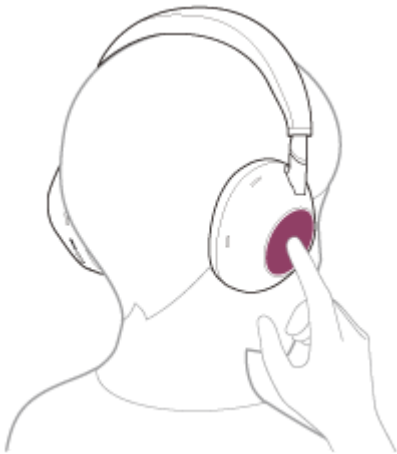

Outgoing call

- Tap the touch sensor control panel twice quickly (with an interval of about 0.4 seconds) to cancel an outgoing call.

Incoming call

- Tap the touch sensor control panel twice quickly to answer a call.
- Hold your finger to the touch sensor control panel to reject a call.

When the head gesture setting is enabled on the “Sony | Sound Connect” app, you can perform the following operations while wearing the headset.

- Receive a call: Nod your head.



- Reject a call: Shake your head.



During call

- If you enable the microphone on/off setting during a call on the “Sony | Sound Connect” app, you can switch the microphone on/off by quickly pressing the NC/AMB (Noise Canceling/Ambient Sound Mode) button twice.
- Tap the touch sensor control panel twice quickly to finish a call.

Supported profile: HSP (Headset Profile)

Outgoing call

- Tap the touch sensor control panel twice quickly to cancel an outgoing call.

Incoming call

- Tap the touch sensor control panel twice quickly to answer a call.

During call

- If you enable the microphone on/off setting during a call on the “Sony | Sound Connect” app, you can switch the microphone on/off by quickly pressing the NC/AMB (Noise Canceling/Ambient Sound Mode) button twice.
- Tap the touch sensor control panel twice quickly to finish a call.

Hint

- While the microphone is off, you will hear a notification sound every 7 seconds to indicate the off state. This notification sound can be turned on/off using the “Sony | Sound Connect” app.

Note

- When [Head Gesture] is enabled on the “Sony | Sound Connect” app, the functions may not work properly with the head gesture controls depending on the connected device or the application you are using.
- Depending on the video calling application you are using, it may not be possible to configure the microphone settings.
- The microphone on/off operation only works with the headset microphone. It does not work with the microphone settings of your smartphone or computer software.

Related Topic

- [Receiving a call](#)
- [Making a call](#)

Making a video call on your computer

When you make a video call on your computer, you can talk wirelessly from your headset.

- 1 **Connect the headset to your computer via a Bluetooth connection.**
- 2 **Launch the video calling application on your computer.**
- 3 **Check the settings* of the video calling application.**
 - When you make a video call on your computer, select calling connections (HFP/HSP) and not music playback connections (A2DP). If you select music playback connections, a video call may not be available.
 - On the speaker settings, select calling connections [Headset (WH-1000XM6 Hands-Free)]**. ([Headphones (WH-1000XM6 Stereo)]** is for music playback connections.)
 - On the microphone settings, select calling connections [Headset (WH-1000XM6 Hands-Free)]**.
 - Depending on the video calling application you are using, calling connections [Headset (WH-1000XM6 Hands-Free)]** or music playback connections [Headphones (WH-1000XM6 Stereo)]** may not be selectable on the speaker or microphone settings, and only [WH-1000XM6] may be displayed. If this is the case, select [WH-1000XM6].
 - As for frequently asked questions and answers, refer to the customer support website.

* Depending on the video calling application you are using, this function may not be available.

** Names may vary according to the computer or the video calling application you are using.

Hint

- When the settings of the video calling application cannot be checked or calling connections [Headset (WH-1000XM6 Hands-Free)] cannot be selected, select [Headset (WH-1000XM6 Hands-Free)] on the settings of your computer to make connections. See [“Connecting to a paired computer \(Windows 11\)”](#), [“Connecting to a paired computer \(Windows 10\)”](#) or [“Connecting to a paired computer \(Mac\)”](#).

Note

- Depending on the video calling application you are using, it may not be possible to configure the microphone settings.
- When Speak-to-Chat is enabled, if the microphone settings are not selected correctly or cannot be configured, the Speak-to-Chat mode is activated when a voice is detected, and the sound from the headset becomes low or may not be audible.
- Depending on the computer or application you are using, the headset may not work properly during a video call. This may be improved by restarting the computer.

Related Topic

- [How to make a wireless connection to Bluetooth devices](#)
- [Pairing and connecting with a computer \(Windows® 11\)](#)
- [Pairing and connecting with a computer \(Windows 10\)](#)
- [Pairing and connecting with a computer \(Mac\)](#)

- [Connecting to a paired computer \(Windows 11\)](#)
- [Connecting to a paired computer \(Windows 10\)](#)
- [Connecting to a paired computer \(Mac\)](#)
- [Disconnecting Bluetooth connection \(after use\)](#)

Using Voice Control

The languages available are “Japanese”, “English”, “Chinese”, “Spanish”, “German”, and “French”.

1 Make the following settings with the “Sony | Sound Connect” app.

- Set [Voice Control / Voice Assistant] to [Operate headphones with Voice Commands]
- Set the language in [Voice Control Language Setting]

2 Speak the wake word.

You can use the following words as wake words:

English: Hey headphones

French: Dis casque

German: Hey Kopfhörer

Spanish: Hey auriculares

Japanese: ハロー ヘッドホン

Chinese: Hey 你好

You will hear a notification sound indicating that the wake word has been accepted, and the system will wait for a voice command input for approx. 8 seconds.

3 Enter voice commands to operate the headset while waiting for input.

You can check available voice commands on the “Sony | Sound Connect” app.

- You can use the Voice Assistant Function of the connected device by speaking the following words instead of the wake word.

English: Assistant

French: Assistant

German: Assistant

Spanish: Asistente

Japanese: アシスタント

Chinese: 语音助手

When the command is hard to detect

- Repeat the command clearly in a loud voice.
- If your surroundings are noisy, your voice may not be recognized properly.
- If the headset volume is too loud, your voice may not be recognized properly.
- After you say “アシスタント”, “Assistant”, “Asistente”, or “语音助手”, it may take about 2 seconds for the Voice Assistant Function to start up.

Wireless Noise Canceling Stereo Headset
WH-1000XM6

Using Google Assistant

May not be supported in some countries or regions.

By using the Google Assistant feature that comes with the smartphone, you can speak to the headset's left and right microphones to operate the smartphone or perform a search.

Compatible smartphones

- Smartphones installed with Android™ 6 or later

1 Launch the “Sony | Sound Connect” app, and set the touch sensor control panel as the Google Assistant feature.

When using Google Assistant for the first time, launch the Google Assistant app and touch [Finish headphones setup] on the Conversation View, and follow the on-screen instructions to complete initial setup for Google Assistant.

2 Say “Hey Google” or operate the touch sensor control panel to use Google Assistant.



Hold your finger to the touch sensor control panel to input a voice command, and release your finger to finish the voice command.

For details on Google Assistant, refer to the following website:

For models of countries and regions excluding Chinese mainland:

For details on the Google app, refer to the operating instructions or the support website of the Android smartphone, or the Google Play store website.

<https://assistant.google.com>

<https://g.co/headphones/help>

For models of Chinese mainland:

For details on the Google app, refer to the operating instructions or the support website of the Android smartphone.

<https://g.co/headphones/help>

Operating the headset with Google Assistant

By saying specific words on Google Assistant, you can perform noise canceling settings or other operations of the headset.

For details, refer to the following website* :

* It is not the case that the headset is compatible with all the specifications described in the web site.

Hint

- Check or update the software version of the headset with the “Sony | Sound Connect” app.
- When Google Assistant is not available for reasons such as not being connected to the network, the voice guidance “The Google Assistant is not connected” is heard.
- If you do not see [Finish headphones setup] on the Conversation View of the Google Assistant app, delete the pairing information for the headset from the Bluetooth settings of your smartphone and redo the pairing process.
- It is possible not to assign the voice assistant to the touch sensor control panel.

Note

- If the function of the touch sensor control panel is set as Google Assistant, the voice assist function (Google app) cannot be used.
- If the function of the touch sensor control panel is set as Google Assistant, the voice assist function (Siri) cannot be used.
- Google Assistant is not available in certain languages, countries and region.
- The function to operate the headset with Google Assistant depends on the specifications of Google Assistant.
- The specifications of Google Assistant are subject to change without notice.
- For details on the services provided by other companies such as Google Assistant, consult each service provider directly. Sony shall assume no responsibility for any problems such as misunderstandings related to the services provided by other companies.

Wireless Noise Canceling Stereo Headset
WH-1000XM6

Using Tencent Xiaowei

For models of Chinese mainland.

By using Tencent Xiaowei that comes with the smartphone, you can speak to the headset's microphone to operate the smartphone or perform a search.

Compatible smartphones

- 安装了Android 6或更新版本，或iOS 10或更新版本的智能手机。
- 需要使用最新的腾讯小微App。

- 1 **Launch the “Sony | Sound Connect” app, and set the touch sensor control panel as the Tencent Xiaowei feature.**
- 2 **Launch the Tencent Xiaowei app.**
- 3 **Operate the touch sensor control panel to use the Tencent Xiaowei app.**



- Hold your finger to the touch sensor control panel to input a voice command, and release your finger to finish the voice command.

For details on Tencent Xiaowei, refer to the following website:

<https://xiaowei.tencent.com/guide/index.html?cid=1465>

Hint

- Check or update the software version of the headset with the “Sony | Sound Connect” app.

Note

- If the function of the touch sensor control panel is set as Tencent Xiaowei, the voice assist function (Google app) cannot be used.
- If the function of the touch sensor control panel is set as Tencent Xiaowei, you cannot activate Siri on the iPhone by using the touch sensor control panel.
- If the function of the touch sensor control panel is set as Tencent Xiaowei, Google Assistant cannot be used from the headset.

- Tencent Xiaowei is only available in China.

5-063-141-11(5) Copyright 2025 Sony Corporation

Wireless Noise Canceling Stereo Headset
WH-1000XM6

Using the voice assist function (Google app)

By using the Google app that comes with the Android smartphone, you can speak to the headset's left and right microphones to operate the Android smartphone.

1 Set the assist and voice input selection to the Google app.

On the Android smartphone, select [Settings] - [Apps & notifications] - [Advanced] - [Default apps] - [Assist & voice input], and set [Assist app] to the Google app.

The operation above is an example. For details, refer to the operating instructions for the Android smartphone.

Note: The latest version of the Google app may be required.

For models of countries and regions excluding Chinese mainland:

For details on the Google app, refer to the operating instructions or the support website of the Android smartphone, or the Google Play store website.

For models of Chinese mainland:

For details on the Google app, refer to the operating instructions or the support website of the Android smartphone.

The Google app may not be activated from the headset depending on specifications of the Android smartphone.

2 Connect the headset to the Android smartphone via Bluetooth connection.

3 When the Android smartphone is in standby or playing music, hold your finger to the headset's touch sensor control panel.



The Google app is activated.

4 Talk to Google through the app while wearing the headset on your ears.

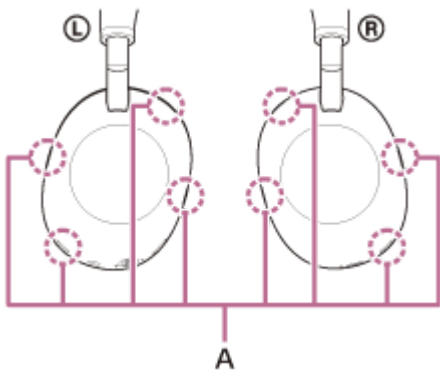

There are microphones (A) on the left and right units of the headset.

For details on the apps which work with the Google app, refer to the operating instructions for the Android smartphone.

After activating the Google app, the voice command is canceled when a certain time has passed without requests.

Note

- If the touch sensor control panel is set as the Google Assistant feature, the voice assist function (Google app) is not available.
- If the touch sensor control panel is set as the Tencent Xiaowei feature, the voice assist function (Google app) is not available.
- The Google app cannot be activated when you say “Hey Google” even when the Android smartphone’s “Hey Google” setting is on.
- In order to make it easier for you to hear your own voice during a phone call, the microphones work to capture ambient sounds (Sidetone function). If your voice is too loud or the sounds in your surroundings are bothering you, turn off [Capture Voice During a Phone Call] on the “Sony | Sound Connect” app.
- The Google app may not be activated depending on specifications of the smartphone or application version.
- The Google app does not work when connected to a device not compatible with the voice assist function.

Wireless Noise Canceling Stereo Headset
WH-1000XM6

Using the voice assist function (Siri)

By using Siri that comes with iPhone, you can speak to the headset's left and right microphones to operate the iPhone.

1 Turn Siri on.

On iPhone, select [Settings] - [Siri & Search] to turn [Press Home for Siri] and [Allow Siri When Locked] on. The operation above is an example. For details, refer to the operating instructions for the iPhone.

Note: For details on Siri, refer to the operating instructions or support website of the iPhone.

2 Connect the headset to the iPhone via Bluetooth connection.

3 When the iPhone is in standby or playing music, hold your finger to the headset's touch sensor control panel.



Siri is activated.

4 Make a request to Siri while wearing the headset on your ears.

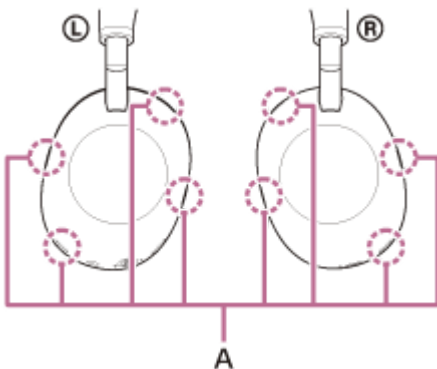

There are microphones (A) on the left and right units of the headset.

For details on the apps which work with Siri, refer to the operating instructions for the iPhone.

After activating Siri, Siri will be deactivated when a certain time has passed without requests.

Note

- If the touch sensor control panel is set as the Google Assistant feature, Siri is not available.
- If the touch sensor control panel is set as the Tencent Xiaowei feature, Siri is not available.
- Siri cannot be activated when you say “Hey Siri” even when the iPhone’s “Hey Siri” setting is on.
- In order to make it easier for you to hear your own voice during a phone call, the microphones work to capture ambient sounds (Sidetone function). If your voice sounds too loud or the sounds in your surroundings are bothering you, turn off [Capture Voice During a Phone Call] on the “Sony | Sound Connect” app.
- Siri may not be activated depending on specifications of the smartphone or application version.

Wireless Noise Canceling Stereo Headset
WH-1000XM6

What you can do with the “Sony | Sound Connect” app

When you connect the smartphone with the “Sony | Sound Connect” app installed and the headset via a Bluetooth connection, you can do the following.

- Update the headset software
- Switch the voice guidance language
- Turn the voice guidance on/off
- Set the voice guidance volume
- Set the voice assistant*
- Set the Quick Access function*
- Turn Service Link on/off*
- Turn the touch sensor control panel on/off
- Set the Bluetooth connection mode (sound quality mode)*
- Turn the sidetone on/off
- Turn off the headset
- Set the wearing detection automatic power off function
- Set the wearing detection automatic music playback pause and resume function
- Check the connection status and the settings of the headset
- Set the multipoint connection (connecting the headset to 2 devices simultaneously)
- LE Audio connection setting for headset
- Initialize the headset
- Check the headset software version
- Turn the head gesture detection on/off
- Display the LE Audio connection status
- Display the Bluetooth connection codec
- Display the DSEE Extreme function setting status
- Set the DSEE Extreme function
- Display the remaining battery charge of the headset
- Select the Equalizer setting for music and gaming
- Customize the Equalizer setting
- Adjust the noise canceling function and Ambient Sound Mode (ambient sound control)
- Select the switching pattern when switching the noise canceling function/Ambient Sound Mode on the headset
- Turn the auto ambient sound on/off
- Set the sensitivity for ambient sound detection
- Use auto adjustment of the noise canceling function by behavior recognition (Adaptive Sound Control)
- Enable/disable the automatic audio detection for Speak-to-Chat and set it up
- Set the BGM effects
- Adjust the volume during music playback/phone call
- Play/pause music or skip to the beginning of the previous track (or the current track during playback)/skip to the beginning of the next track
- Easy pairing*
- Switch the Voice Control language
- Turn safe listening on/off
- Set the spatial sound and head tracking function
- Set the Auto Play function
- Seamless playback with speakers (Auto Switch)*
- Set the 360 Upmix for Cinema function
- Turn the microphones on/off during a call

* Cannot be used during LE Audio connection.

Hint

- The operation of the “Sony | Sound Connect” app differs depending on the audio device. The app specifications and screen design may change without prior notice.

Note

- BGM effects are disabled during a call.

Related Topic

- [Installing the “Sony | Sound Connect” app](#)
- [Checking the remaining battery charge](#)
- [Using the noise canceling function](#)
- [Always automatically optimizing the noise canceling performance to suit the wearer and usage environment](#)
- [Listening to ambient sound during music playback \(Ambient Sound Mode\)](#)
- [About the sound quality mode](#)
- [Supported codecs](#)
- [About the DSEE Extreme function](#)
- [Automatically adjusting the level of ambient sound capture according to the ambient noise level \(Auto Ambient Sound\)](#)
- [Speaking with someone while wearing the headset \(Speak-to-Chat\)](#)
- [Connecting the headset to 2 devices simultaneously \(multipoint connection\)](#)
- [About 360 Reality Audio](#)
- [Enjoying seamless playback with speakers \(Auto Switch\)](#)
- [Using 360 Upmix for Cinema](#)
- [Functions for a phone call](#)

Wireless Noise Canceling Stereo Headset
WH-1000XM6

Installing the “Sony | Sound Connect” app

1 Download the “Sony | Sound Connect” app, and install the app on your smartphone.

For models of countries and regions excluding Chinese mainland, you can download from the Google Play store or App Store.



Sony Sound Connect 

2 After installing the app, launch the “Sony | Sound Connect” app.

Related Topic

- [What you can do with the “Sony | Sound Connect” app](#)

Wireless Noise Canceling Stereo Headset
WH-1000XM6

Accessing support information from the “Sony | Sound Connect” app

You can access the latest support information from the “Sony | Sound Connect” app.

- 1 Tap [Help] on the “Sony | Sound Connect” app screen to see the support page.
- 2 Select the desired item.

Wireless Noise Canceling Stereo Headset
WH-1000XM6

How to keep the software up-to-date (for comfortable use of the headset)

Install the latest headset software using the “Sony | Sound Connect” app to enjoy new functions or to resolve a certain number of issues with the headset.

Always use the headset with the latest software installed.

For details on the latest headset software and how to update the software, refer to the information on the support website.

When the update automatically setting is enabled on the “Sony | Sound Connect” app and the following conditions are met, the software update starts automatically at around night time when the headset is not in use.

- The software has already transferred.
- The remaining battery charge of the headset units is more than 20%.
- The headset is turned off.

You can also update the headset software in the following way.

1 Turn on the headset.

Press and hold the  (power) button (A) for about 2 seconds or more.

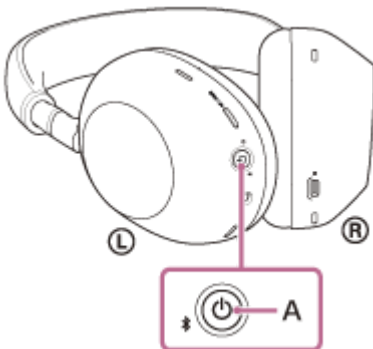

2 Launch the “Sony | Sound Connect” app on a mobile device such as a smartphone.

3 Update the headset software following the on-screen instructions.

Note

- When the mobile device used for the update has any other Bluetooth devices connected to it, turn off all the Bluetooth devices until the update is complete.
Software may not be updated when the mobile device is connected with other devices compatible with Bluetooth Low Energy (such as wearable devices, smart watches, etc.).
- Note the following if the update cannot be completed.
 - Close all the apps installed on the mobile device except the “Sony | Sound Connect” app.
 - Fully charge the headset and the mobile device.
 - Put the headset and the mobile device being used for the update as close to each other as possible before starting the update.
 - Keep wireless LAN devices and other Bluetooth devices away from the headset when updating.
 - Turn off the power saving mode* of your mobile device before updating the software.
Depending on the OS version of your mobile device, the update may not be completed under the power saving mode.

* Names may vary according to the mobile device you are using.

Related Topic

- [What you can do with the “Sony | Sound Connect” app](#)

5-063-141-11(5) Copyright 2025 Sony Corporation

Wireless Noise Canceling Stereo Headset
WH-1000XM6

What you can do with partner services

After setting up on the “Sony | Sound Connect” app, you can use the apps linked with the headset.

For details on the apps that can be linked, refer to the following URL.

<https://www.sony.net/supported-servicelink>

For details on the latest services and experiences you can have by linking, check the [Services] tab of the “Sony | Sound Connect” app.

- 1 Launch the “Sony | Sound Connect” app.
- 2 Set up each service with the “Sony | Sound Connect” app.

Note

- The services that can be linked differ depending on the countries and regions.
- The specifications of the services that can be linked are subject to change, suspension or termination without notice.
- The corresponding app needs to be installed.
- For details on Service Link, refer to the following URL.
[sony.net/servicelink](https://www.sony.net/servicelink)

Related Topic

- [Installing the “Sony | Sound Connect” app](#)

Precautions

On Bluetooth communications

- Bluetooth wireless technology is a short-range wireless technology that enables communication between digital devices, such as smartphones and computers. The maximum communication distance may vary depending on the presence of obstacles (people, metal objects, walls, etc.) or the electromagnetic environment.
- Microwaves emitting from a Bluetooth device may affect the operation of electronic medical devices. Turn off the headset and other Bluetooth devices in the following locations, as it may cause an accident:
 - in hospitals, near priority seating in trains, locations where inflammable gas is present, near automatic doors, or near fire alarms.
- This product emits radio waves when used in wireless mode. When used in wireless mode on an airplane, follow flight crew directions regarding permissible use of products in wireless mode.
- The audio playback on the headset may be delayed from that on the transmitting device, due to the characteristics of Bluetooth wireless technology. As a result, the sound may not be in sync with the image when viewing movies or playing games.
- The headset supports security functions that comply with the Bluetooth standard as a means of ensuring security during communication using Bluetooth wireless technology. However, depending on the configured settings and other factors, this security may not be sufficient. Be careful when communicating using Bluetooth wireless technology.
- Sony shall assume no responsibility for any damages or loss resulting from information leaks that occur when using Bluetooth communications.
- Bluetooth connections with all Bluetooth devices cannot be guaranteed.
 - Bluetooth devices connected with the headset must comply with the Bluetooth standard prescribed by Bluetooth SIG, Inc., and must be certified as compliant.
 - Even when a connected device complies with the Bluetooth standard, there may be cases where the characteristics or specifications of the Bluetooth device make it unable to connect, or result in different control methods, display, or operation.
 - When using the headset to perform hands-free talking on the phone, noise may occur depending on the connected device or the communication environment.
- Depending on the device to be connected, it may require some time to start communications.

Note on static electricity

- If you use the headset when the air is dry, you may experience discomfort due to static electricity accumulated on your body. This is not a malfunction of the headset. You can reduce the effect by wearing clothes made of natural materials that do not easily generate static electricity.

Notes on wearing the headset

- Because the headset achieves a tight seal over the ears, forcibly pressing it against your ears or quickly pulling it off can result in eardrum damage. When putting on the headset, the speaker diaphragm may produce a click sound. This is not a malfunction.

Other notes

- Do not subject the headset to excessive shock as it is a precision device.
- The touch sensor may not operate properly if you apply stickers or other adhesive items to the touch sensor control panel.
- Be careful not to catch your finger in the headset when folding.
- When you use the headset as wired headphones, use the supplied headphone cable only. Make sure that the headphone cable is firmly inserted.

- Depending on the signal conditions of your smartphone or the surrounding environment, you may not be able to use the headset.
- Do not apply weight or pressure to the headset for long periods, including when it is stored, as it may cause deformation.
- If you experience discomfort while using the headset, stop using it immediately.
- The earpads may be damaged or deteriorate with long-term use and storage.
- The headset is not waterproof. If water or foreign matter enters the headset, it may result in fire or electric shock. If water or foreign matter enters the headset, stop use immediately, and consult the Sony support contact or your nearest Sony dealer.

Cleaning the headset

- Dust and dirt on the exterior of the headset can be wiped off with pure water type wet wipes. Do not use wet wipes containing alcohol, thinner, benzene, etc. as they may damage the finish on the surface of the headset or cause other damages.

Do not use the headset near medical devices

- Radio waves can affect cardiac pacemakers and medical devices. Do not use the headset in crowded places such as crowded trains or inside a medical institution.
- The headset has magnet(s) which may interfere with pacemakers, programmable shunt valves for hydrocephalus treatment, or other medical devices. Do not place the headset close to persons who use such medical devices. Consult your doctor before using the headset if you use any such medical devices.

Keep the headset away from magnetic cards

- The headset has magnets. If a magnetic card comes near the headset, the card magnet may be affected or become deactivated.

Wireless Noise Canceling Stereo Headset
WH-1000XM6

To prevent burning or malfunction due to getting wet

On waterproof performance of the headset

The headset is not waterproof. If water or foreign matter enters the headset, this can result in burnout or malfunction.

Avoid situations such as the following and be careful not to expose the headset to moisture or dirt.

- Using the headset in the rain or snow.



- Touching the headset without drying wet hands after doing housework in the kitchen or washing hands in the washroom.

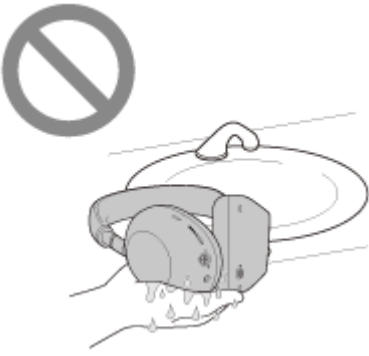

- Touching the headset with sweaty hands, or using the headset in situations where the headset may get soaked in sweat.



- Putting the headset in a bag with a cold PET bottle.



If the headset gets wet, or water enters the headset

If a wet headset is charged or turned on, this can result in burnout or malfunction. Turn the headset over with as little restraint as possible and apply a dry cloth to the headset until no more water comes out of the hole at the base of the slider section. After that, leave the headset in a shaded, well-ventilated place until it is completely dry.

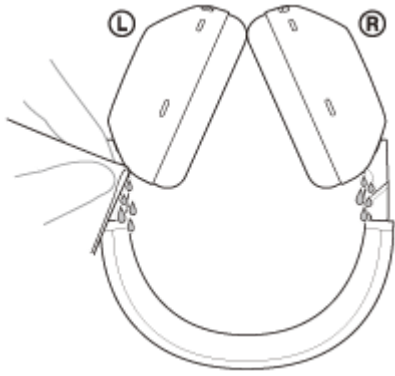

5-063-141-11(5) Copyright 2025 Sony Corporation

Licenses

- This product contains software that Sony uses under a licensing agreement with the owner of its copyright. We are obligated to announce the contents of the agreement to customers under requirement by the owner of copyright for the software. Please access the following URL and read the contents of the license.
<https://rd1.sony.net/help/mdr/sl/25/>
- Use of the Made for Apple badge means that an accessory has been designed to connect specifically to the Apple product(s) identified in the badge and has been certified by the developer to meet Apple performance standards. Apple is not responsible for the operation of this device or its compliance with safety and regulatory standards.
- Network services, content and the (operating system and) software of this product may be subject to individual terms and conditions and changed, interrupted or discontinued at any time and may require fees, registration and credit card information.

Trademarks

- Google, Android and Google Play are trademarks of Google LLC.
- Apple, iPhone, macOS, Mac and Siri are trademarks of Apple Inc., registered in the U.S. and other countries and regions.
- App Store is a service mark of Apple Inc., registered in the U.S. and other countries and regions.
- IOS is a trademark or registered trademark of Cisco in the U.S. and other countries and is used under license.
- Microsoft and Windows are registered trademarks or trademarks of Microsoft Corporation in the United States and/or other countries.
- The Bluetooth® word mark and logos are registered trademarks owned by Bluetooth SIG, Inc. The Auracast™ word mark and logos are trademarks owned by Bluetooth SIG, Inc. Any use of such marks by Sony Group Corporation and its subsidiaries is under license.
- USB Type-C® and USB-C® are registered trademarks of USB Implementers Forum.
- LDAC and LDAC logo are trademarks of Sony Group Corporation or its affiliates.
- “DSEE” and “DSEE Extreme” are trademarks or registered trademarks of Sony Group Corporation or its affiliates.
- All other trademarks and registered trademarks are trademarks or registered trademarks of their respective holders. In this manual, ™ and ® marks are not specified.

Wireless Noise Canceling Stereo Headset
WH-1000XM6

Customer support websites

For customers in the U.S.A, Canada, and Latin America:

<https://www.sony.com/am/support>

For customers in European countries:

<https://www.sony.eu/support>

For customers in China:

<https://service.sony.com.cn>

For customers in other countries/regions:

<https://www.sony-asia.com/support>

Wireless Noise Canceling Stereo Headset
WH-1000XM6

Troubleshooting

If you have any problems, please follow the process below.

1. Turn the headset off, charge it, and then turn it on again.



2. Restart the device being connected such as your computer or smartphone.



3. Access the Sony support site from the menu of the “Sony | Sound Connect” app to search for the cause and solution of the issue, or check the support site below.

<https://www.sony.net/support/WH-1000XM6/>



4. Reset the headset.



5. Initialize the headset.



6. Should any problems persist, consult the Sony support contact below or your nearest Sony dealer.

<https://www.sony.net/support-contact>

Related Topic

- [Charging the headset](#)
- [Customer support websites](#)
- [Resetting the headset](#)
- [Initializing the headset to restore factory settings](#)

Wireless Noise Canceling Stereo Headset
WH-1000XM6

Resetting the headset

If the headset cannot be turned on or cannot be operated even when it is turned on, reset the headset.

1 Connect the headset to an AC outlet.

Use the supplied USB Type-C cable and a commercially available USB AC adaptor (A).

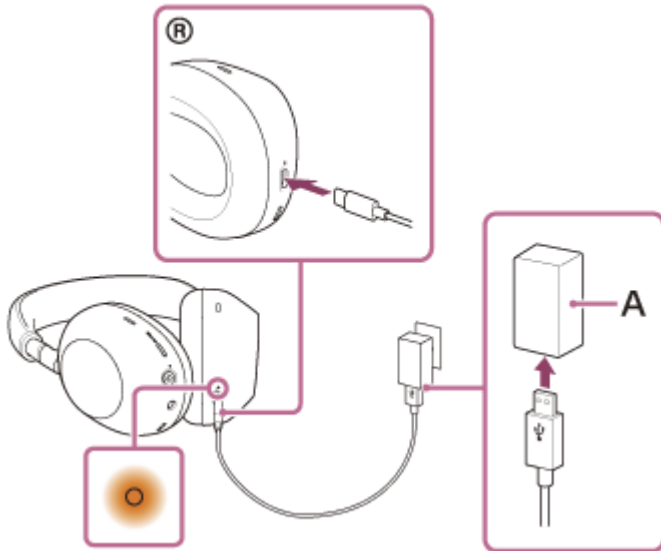

2 Press and hold the (power) button (B) and the NC/AMB (noise canceling/Ambient Sound Mode) button (C) for about 5 seconds.

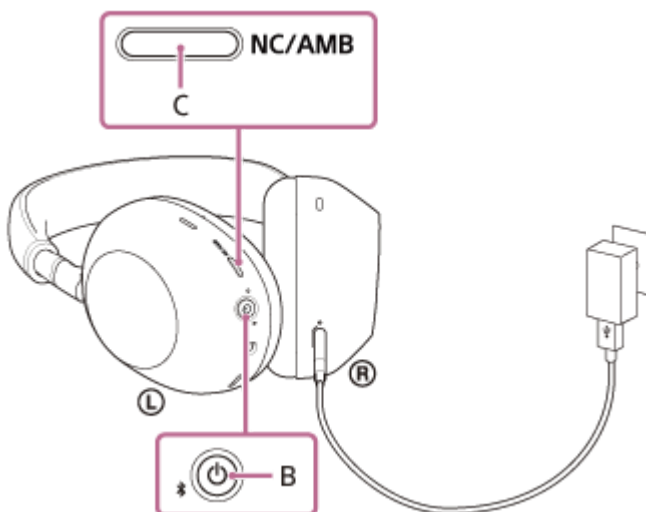

The headset will be reset (the charging indicator turns off and then lights up again).

The pairing information and other settings are retained.

If the headset does not operate correctly even after resetting, initialize the headset to restore factory settings.

Related Topic

- [Initializing the headset to restore factory settings](#)

5-063-141-11(5) Copyright 2025 Sony Corporation

Wireless Noise Canceling Stereo Headset
WH-1000XM6

Initializing the headset to restore factory settings

If the headset does not operate correctly even after resetting, initialize the headset.

1 Turn off the headset.

Remove the USB Type-C cable.

2 Press and hold the (power) button (A) and the NC/AMB (noise canceling/Ambient Sound Mode) button (B) for about 10 seconds.

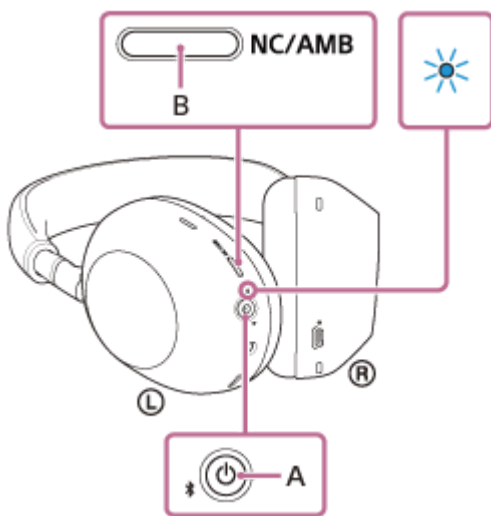

When the initializing is complete, the indicator (blue) flashes 4 times (● - ● - ● - ● -).

This operation resets volume settings, etc. to the factory settings, and deletes all pairing information. In this case, delete the pairing information for the headset from the connected device and then pair them again.

If the headset does not operate correctly even after initializing, consult the Sony support contact or your nearest Sony dealer.

Related Topic

- [Resetting the headset](#)

Wireless Noise Canceling Stereo Headset
WH-1000XM6

Specifications

Headset

Power source:

DC 5 V / 1.5 A (Using a commercially available USB Normal AC Adaptor)
DC 5 V / 1.5 A and 9 V / 2.3 A (Using a commercially available USB Power Delivery AC adaptor)
or use built-in lithium-ion batteries (Product Operation Power: DC 3.8 V)

Operating temperature:

0 °C to 40 °C (32 °F to 104 °F)

Charging time:

Approx. 3.5 hours

Note

- Charging hours may be different depending on the conditions of use.

Charging temperature:

5 °C to 35 °C (41 °F to 95 °F)

Mass:

Approx. 254 g (9 oz)

Impedance:

48 Ω (1 kHz) (when connecting via the headphone cable with the headset turned on)
16 Ω (1 kHz) (when connecting via the headphone cable with the headset turned off)

Sensitivity:

103 dB/mW (when connecting via the headphone cable with the headset turned on)
102 dB/mW (when connecting via the headphone cable with the headset turned off)

Frequency response:

4 Hz - 40 000 Hz (IEC)¹⁾
(when connecting via the headphone cable with the headset turned on)

Communication specification

Communication system:

Bluetooth Specification version 5.3

Output:

Bluetooth Specification Power Class 1

Maximum communication range:

Line of sight approx. 10 m (32.8 ft) ²⁾

Frequency band:

Bluetooth: 2.4 GHz band (2.400 0 GHz - 2.483 5 GHz)

Compatible Bluetooth profiles ³⁾:

A2DP/AVRCP/HFP/HSP
TMAP/GMAP/PBP

Supported Codec ⁴⁾:

SBC
AAC
LDAC
LC3

Transmission range (A2DP):

20 Hz - 20 000 Hz (Sampling frequency 44.1 kHz)
20 Hz - 40 000 Hz (Sampling frequency LDAC 96 kHz, 990 kbps)

- 1) IEC = International Electrotechnical Commission
- 2) The actual range will vary depending on factors such as obstacles between devices, magnetic fields around a microwave oven, static electricity, reception sensitivity, antenna's performance, operating system, software application, etc.
- 3) Bluetooth standard profiles indicate the purpose of Bluetooth communications between devices.
- 4) Codec: Audio signal compression and conversion format

Design and specifications are subject to change without notice.

Compatible iPhone models

iPhone 15 Pro Max
iPhone 15 Pro
iPhone 15 Plus
iPhone 15
iPhone 14 Pro Max
iPhone 14 Pro
iPhone 14 Plus
iPhone 14
iPhone SE (3rd generation)
iPhone 13 Pro Max
iPhone 13 Pro
iPhone 13
iPhone 13 mini
iPhone 12 Pro Max
iPhone 12 Pro
iPhone 12
iPhone 12 mini
iPhone SE (2nd generation)
iPhone 11 Pro Max
iPhone 11 Pro
iPhone 11
iPhone XS Max
iPhone XS
iPhone XR
iPhone X
iPhone 8 Plus
iPhone 8

(As of January 2025)

5-063-141-11(5) Copyright 2025 Sony Corporation